



Wireless system

4611, 4613, 4614,
4620, AND 4645

Fire alarm solutions
technical description

Table of Contents

1.	INTRODUCTION	4
2.	ABBREVIATIONS	5
3.	GENERAL DESCRIPTION	6
3.1.	COMMUNICATION	6
3.1.1.	TRANSMISSION CHANNEL (0-3)	7
3.1.2.	BACKUP CHANNELS (4-7)	7
3.1.3.	COMMUNICATION BETWEEN THE WIRELESS DETECTOR SYSTEM AND THE CIE	8
3.1.4.	TEMPORARY DISTURBANCES	9
3.1.5.	FIRE ALARM	9
3.1.6.	DIRECTIONAL CHARACTERISTICS	10
3.1.7.	TRANSMISSION RANGE	12
4.	WIRELESS PHOTOELECTRIC SMOKE DETECTOR 4611	15
4.1.	BASIC INFORMATION	15
4.2.	IR LED	16
4.3.	FIRE ALARM	16
4.4.	SENSITIVITY COMPENSATION	16
4.4.1.	SERVICE SIGNAL	16
4.5.	SET THE COM LOOP ADDRESS - EBLWin PROGRAMMING	17
4.6.	SET THE WIRELESS UNIT ADDRESS	18
4.7.	SET THE TRANSMISSION CHANNEL	19
4.8.	REGISTER A WIRELESS UNIT	20
4.8.1.	CHECK REGISTRATION	21
4.9.	SET TO UNREGISTER MODE	22
4.9.1.	UNREGISTER ONE WIRELESS UNIT	22
4.9.2.	UNREGISTER ALL WIRELESS UNITS	23
4.10.	MANUAL SIGNAL CHECK	24
5.	WIRELESS MANUAL CALL POINT 4614	25
5.1.	BASIC INFORMATION	25
5.2.	FIRE ALARM	27
5.3.	SET THE COM LOOP ADDRESS - EBLWin PROGRAMMING	27
5.4.	SET THE WIRELESS MANUAL CALL POINT ADDRESS	28
5.5.	SET THE TRANSMISSION CHANNEL	28
5.6.	REGISTER A WIRELESS MANUAL CALL POINT	28
5.7.	SET TO UNREGISTER MODE	28
5.8.	MANUAL SIGNAL CHECK	28
6.	WIRELESS LOCAL ALARM ACKNOWLEDGE UNIT 4645	29
6.1.	FIRE ALARM	30
6.2.	SET THE COM LOOP ADDRESS - EBLWin PROGRAMMING	31
6.3.	SET THE WIRELESS LOCAL ALARM ACKNOWLEDGE UNIT	32
6.4.	SET THE TRANSMISSION CHANNEL	32
6.5.	REGISTER A WIRELESS LOCAL ALARM ACKNOWLEDGE UNIT	32

6.6.	SET TO UNREGISTER MODE	32
6.7.	MANUAL SIGNAL CHECK	32
7.	ADDRESSABLE BASE STATION FOR WIRELESS UNITS 4620	33
7.1.	BASIC INFORMATION	33
7.2.	CONNECTIONS	34
7.3.	SET THE COM LOOP ADDRESS - EBLWin PROGRAMMING	35
7.4.	SET THE TRANSMISSION CHANNEL	37
7.5.	SET TO INSTALL MODE	38
7.6.	SET TO REGISTER MODE	39
7.7.	SET TO UNREGISTER MODE	40
7.8.	MODE DIL	41
7.8.1.	REGISTER WITH MODE DIL	42
8.	WIRELESS SNIFFER 4613	43
8.1.	BASIC INFORMATION	43
8.2.	CHECK THE BACKGROUND	45
8.3.	CHECK THE COMMUNICATION	46
9.	COMMISSIONING THE WIRELESS SYSTEM	49
10.	TECHNICAL DATA	50
11.	DECLARATION OF CONFORMITY	56
12.	APPROVALS	58

1. INTRODUCTION

This document describes:

- Wireless photoelectric smoke detector 4611
- Wireless manual call point 4614
- Wireless local alarm acknowledge unit 4645
- Addressable base station for wireless units 4620
- Wireless sniffer 4613

The expression "wireless detector system" is found in this document and refers to one base station and up to 16 wireless units.

"EBL system" refers to the control units EBL128, EBLOne, or EBL512 G3.

2. ABBREVIATIONS

CIE	Control and indicating equipment	= control unit
CU	Control Unit	
DIL	Dual-In-Line	
LED	Light Emitting Diode	
IR	Infrared	
SSD	Site Specific Data	
WLAU	Wireless local alarm acknowledge unit	
WMCP	Wireless Manual Call Point	

3. GENERAL DESCRIPTION

3.1. COMMUNICATION

The wireless detector system consists of an Addressable base station for wireless units 4620, Wireless photoelectric smoke detectors 4611, Wireless manual call point 4614, and Wireless local alarm acknowledge unit 4645.

In an EBL system, up to four base stations can be connected to each COM loop, including the SUB-loops.

Each base station can communicate with up to 16 wireless units. The base station communicates on a selected channel with each wireless unit every two minutes.

- One transmission channel (0, 1, 2 or 3) is set for each base station.
- One transmission channel (0, 1, 2 or 3) is set for each wireless unit (0-15), depending on which base station it shall communicate with.
- The transmission channel (0, 1, 2 or 3) is set on the DIL-switches in the Addressable base station and the wireless units respectively, see section 4.7. SET THE TRANSMISSION CHANNEL and 7.4. SET THE TRANSMISSION CHANNEL.

When more than four base stations are required, see section 3.1.1. TRANSMISSION CHANNEL (0-3) on page 7.

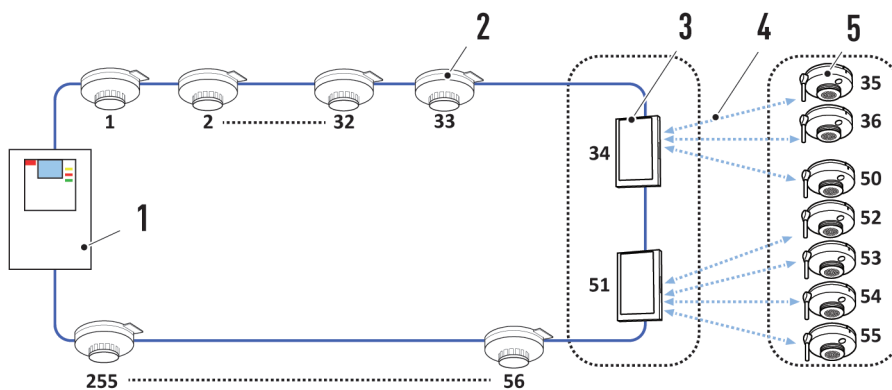

1. Control unit (CIE)
2. Detector on COM loop
3. Base station
4. Wireless communication
5. Wireless smoke detector

The illustration shows two Wireless detector systems on one COM loop. The base stations, no. 0 and no. 1, are set to transmission channel 0 and 1 respectively.

3.1.1. TRANSMISSION CHANNEL (0-3)

Up to four base stations can be connected to a COM loop and they shall be set to transmission channel 0, 1, 2 and 3 respectively. In order to have the wireless units to communicate with its base station, the transmission channel (0, 1, 2 or 3) shall be set to the same in the units as in its base station.

The distance between the base stations and the wireless units, using a different transmission channel has to be more than 2 meters. The same is valid for the distance between the base stations or the distance between the wireless units using a different transmission channel.

3.1.2. BACKUP CHANNELS (4-7)

Changes in the installation / building could affect the communication between the base station and its wireless units. If the base station does not receive a proper answer, it will start communicating on all the four backup channels (4 – 7) as well. The wireless unit will then answer on the channel with the best signal.

Next time the communication starts it will be on the selected channel again and in case of a not proper answer the "backup" channels will be used again. And so on.

If the base station does not receive any proper answer when it is communicating on all the five channels, the base station will directly make a new attempt, and again and again. After approximately 5 minutes, if no proper answer is received, a "no reply" fault will be generated and displayed in the CIE.

3.1.3. COMMUNICATION BETWEEN THE WIRELESS DETECTOR SYSTEM AND THE CIE

Wireless detector / WMCP / WLAAU	Base station	CIE
Fire alarm →	→	Fire alarm Zone-Address
LED on/off	←	Detector LED on/off
Sounder on/off →	←	Detector sounder on/off
Detector / WMCP removal (tamper switch activated) →	→	Fault: Detector xxx-xx / yyyyyy removed
IR LED fault →	→	Fault: Loop unit xxx-xx / yyyyyy
EEPROM fault →	→	
Battery fault (voltage <2.8 V) →	→	Fault: Battery xxx-xx / yyyyyy
Wireless signal stop (voltage <2.3 V) →	→	Fault: No reply xxx-xx / yyyyyy
	No Detector data →	
Sensor compensation value >2.0 % per m >18 h →	→	Service signal xxx-xx / yyyyyy
	EEPROM trouble Base station yyyyyy →	Fault: Loop unit yyyyyy

xxx-xx = Presentation number

yyyyyy = Technical address

Due to the base station's internal priority order, if more than one fault is generated "at the same time", it's depending on the type of faults which will be presented in the CIE.

3.1.4. TEMPORARY DISTURBANCES

If the base station doesn't receive a proper answer, it will start to communicate on "backup" channels (4 – 7) as well. The wireless units will answer on the channel with the best signal, either the selected channel or one of the backup channels.

Next time the communication starts it will be on the selected channel again and in case of a not proper answer the "backup" channels will be used again, and so on.

If the base station does not receive any proper answer when it is communicating on all the five channels, the base station will directly make a new attempt, and again and again. After approximately 5 minutes, if no proper answer is received, a fault will be generated and displayed in the CIE.

3.1.5. FIRE ALARM

When a wireless unit is in fire alarm state it will directly send this information to the base station. The base station will directly send the fire alarm information to the CIE. "Fire alarm" will be activated and displayed in the CIE and a signal will be sent to the wireless unit (via the base station) to turn on the LED and the built-in sounder (detector only). The wireless detector sounder can be programmed for high, medium, and low priority. The sound of the three priorities must differ.

Example:

High priority: Steady (continuously); 3 kHz

Medium priority: 1 Hz (0.5 s ON / 0.5 s OFF); Sweep from 2.8 to 3.2 kHz

Low priority: 1 Hz (0.5 s ON / 0.5 s OFF); 3 kHz

3.1.6. DIRECTIONAL CHARACTERISTICS

WIRELESS PHOTOELECTRIC SMOKE DETECTOR 4611

Directional pattern:

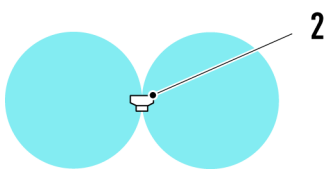
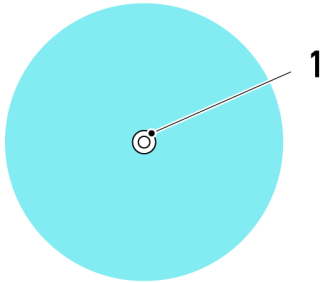

1. Wireless detector top view
2. Wireless detector side view

WIRELESS MANUAL CALL POINT 4614 / LOCAL ALARM ACKNOWLEDGE UNIT 4645

Directional pattern:

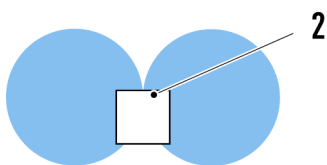
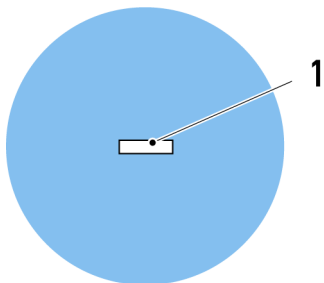

1. Wireless MCP / LAU top view
2. Wireless MCP / LAU side view

ADDRESSABLE BASE STATION 4620

Directional pattern:

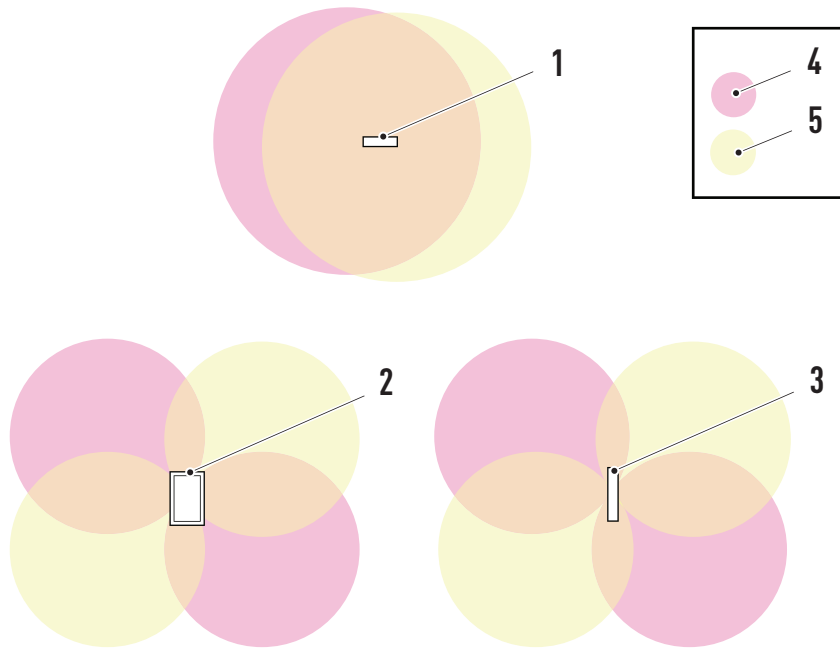

1. Base station top view
2. Base station front view
3. Base station side view
4. Directional pattern antenna 1
5. Directional pattern antenna 2

3.1.7. TRANSMISSION RANGE

According to EN54-25, the transmission signal has to be OK in both directions, including an additional 30 dB "security margin". This is automatically checked during the registration procedure for the wireless units.

The transmission distance is up to 170 meters in open air if the EN54-25 requirements shall be fulfilled.

Open air between the wireless units and the base station is required for the maximum transmission distance. Radio signals are affected by both reflection and attenuation.

REFLECTION

Walls and objects between or close to the wireless units and the base station, as well as the type of material, will affect the radio signal. Reflection of radio waves caused by walls or objects in the building can result in an increase or a reduction of the signal.

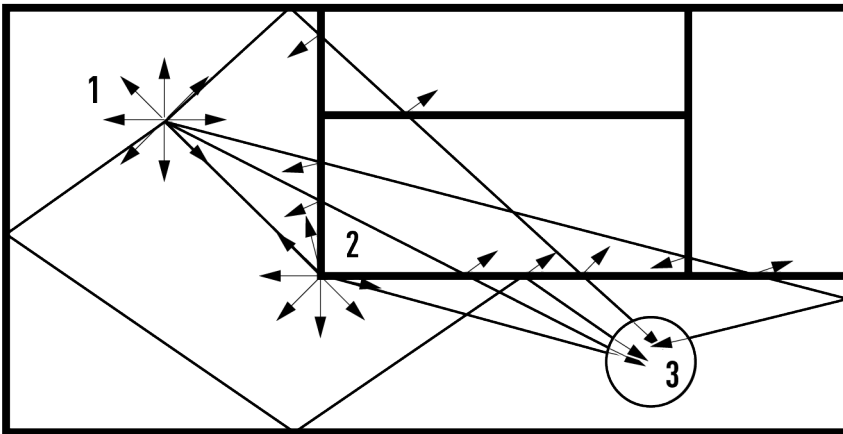

- 1. Transmitter
- 2. Spherical reflections
- 3. Receiver

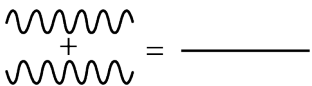
 The resulting signal is impossible to calculate. Tests on site are required.
 The worst result is no signal at all.

During the registration procedure, the wireless unit LED will indicate if the signal is OK or not. See section 4.8. REGISTER A WIRELESS UNIT on page 20.

ATTENUATION

If the following items are between or close to the wireless units, the transmission distance will be affected:

- Metal or material including metal, for example reinforced concrete or glass wool with aluminum foil.
- Wireless station for TV, radio.
- Home electric products or office automation high frequency equipment, such as microwave oven or PC, closer than 2 meters.
- Mobile phone or other wireless systems.
- Human body.

The following table shows the approximate attenuation for different materials:

Thick wet brick walls, reinforced concrete ceiling / floor	30-40 dB
Steel reinforced concrete wall	30 dB
Light concrete wall / ceiling	20 dB
Indoor walls (sand/limestone, brick, wood, plaster etc.)	10-15 dB
Light indoor walls, dividers, etc.	1-5 dB

The exact attenuation for different materials is not possible to calculate in advance, because it is depending not only on the material itself but also the thickness of it.

The attenuation of the wireless signal in open air is approximately 16 dB when you double the distance.

EXAMPLE:

10 m	24 dB
20 m	40 dB
40 m	56 dB
85 m	72 dB
170 m	88 (90) dB

As indicated above, the maximum attenuation must be less than 90 dB.

MORE EXAMPLES:

The following two examples are showing the approximate attenuation for different distances and materials:

Example 1: The distance between the base station and a wireless unit is 85 m (72 dB) and an indoor wall (10 dB) gives an approximate attenuation of 82 dB, which is < 90 dB = OK.

Example 2: The distance between the base station and a wireless unit is 40 m (56 dB) and a reinforced concrete ceiling (40 dB) gives an approximate attenuation of 96 dB, which is more than 90 dB = not OK.

The examples above are theoretical and rough calculations that have to be verified in the actual installation on site. Also note that movements and activities inside the building can affect the wireless signal. The result could vary during the different hours of the day. Because of the large attenuation by reinforced concrete in ceiling / floor, it is recommended to have minimum one base station per level / floor.

A Wireless sniffer is highly recommended to be used, to check the background noise as well as the signals between a base station and its wireless units. See chapter [8. WIRELESS SNIFFER 4613](#).

4. WIRELESS PHOTOELECTRIC SMOKE DETECTOR 4611

4.1. BASIC INFORMATION

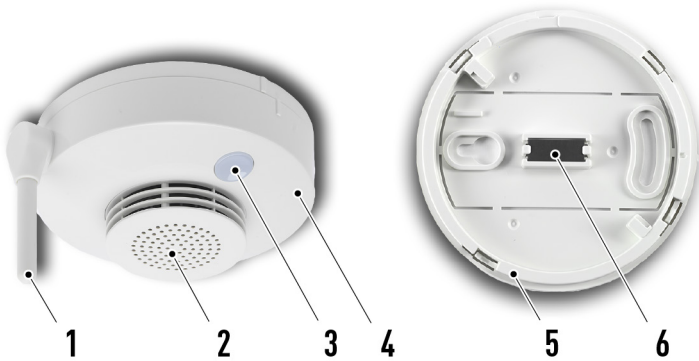

- 4611 consists of a detector (4), which is plugged in a supplied base (5). It must be mounted in the ceiling.
- The detector has an external adjustable antenna (1). The detector shall be mounted with the antenna in the direction towards the base station.
- The built-in sounder (2) has three priority levels. The sounder is programmed as an output via EBLWin.
- The signal check button (3) has an LED for fire alarm indication. For more information on the detector led and signal check button, see [4.10. MANUAL SIGNAL CHECK](#) on page 24.
- The detector has a tamper switch, and on the detector base (5) there is a tamper switch magnet (6) for detector removal signal. Removal of the detector (4) will give a fault message in the CIE.
- The detector chamber is protected by an insect filter. The mesh size is 0.3 mm.

BATTERIES, TYPE NUMBER 4612

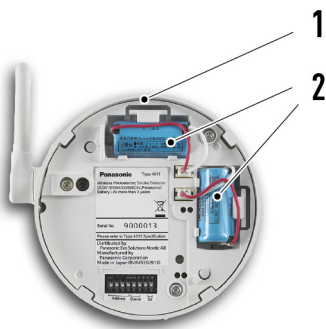

The Wireless detector is powered by two pieces of supplied 3 V Lithium batteries. A battery voltage less than 2.8 V will generate a fault in the CIE. The detector will turn off the wireless signal when the battery voltage is less than 2.3 V, since the function cannot be guaranteed at such a low voltage. A "no reply" fault will then be generated in the CIE. Available as spare part.

The batteries (4612) has six years of service life used in 4611, in normal operation.

When replacing the batteries, remove both batteries for 2 seconds to force a restart of the detector. (The battery fault is latched so a restart is necessary to clear the fault.)

4.2. IR LED

The smoke detection chamber consists of an IR LED and a photodiode. Reflection of the infrared light is used to detect smoke. The smoke enters the detection chamber through an insect filter and an optical labyrinth. This construction improves the smoke inflow and also causes steam to condense on the outer surfaces, to prevent false alarms. The condition of the IR LED is checked every 30 minutes. If the IR LED condition is not OK, a fault will be generated in the CIE after three fault readings. That is after $3 \times 30 (=90)$ minutes.

4.3. FIRE ALARM

The detector performs a fire alarm check every 5.1 second, which changes to 1 second when the value is over the fire alarm threshold level, which is 3.5 % obscuration per meter. In order to reduce false alarms, three values/readings over the alarm threshold level are required before a fire alarm message will be sent to the CIE. The CIE will send a message to turn on the indication LED on the Wireless detector. The CIE will also send a message to turn on the built-in sounder if a control expression is programmed for High, Medium and/or Low priority.

4.4. SENSITIVITY COMPENSATION

In order to maintain a constant sensitivity regardless of the contamination of the detector, a Sensitivity Compensation Factor (SCF) is subtracted from the momentary smoke obscuration values before evaluated in the alarm algorithms. The SCF is calculated during a 36 hours period as follows:

During 13 minutes, all the momentary smoke obscuration values are saved and an average value is calculated. The SCF will be changed directly if the average value is lower than the actual SCF, else no change.

This is valid for 18 hours. Then the SCF will be changed also if the average value is higher than the actual SCF. (It will normally be higher because of contamination.)

After another 18 hours the SCF will be changed if the average value is lower or higher than the actual SCF and it will be saved in the detector's non-volatile memory.

A new $18 + 18 = 36$ hours period starts with an average value calculation every 13th minutes.

4.4.1. SERVICE SIGNAL

A service signal will be activated when the detectors SCF value is 2%/m and the detector has to be replaced.

4.5. SET THE COM LOOP ADDRESS - EBLWin PROGRAMMING

Each wireless unit takes one COM loop address, or Technical address, in EBLWin. The wireless unit address will be the base station's COM loop address +1, +2, up to +16.

EBLWin dialog box "Wireless photoelectric smoke detector 4611."

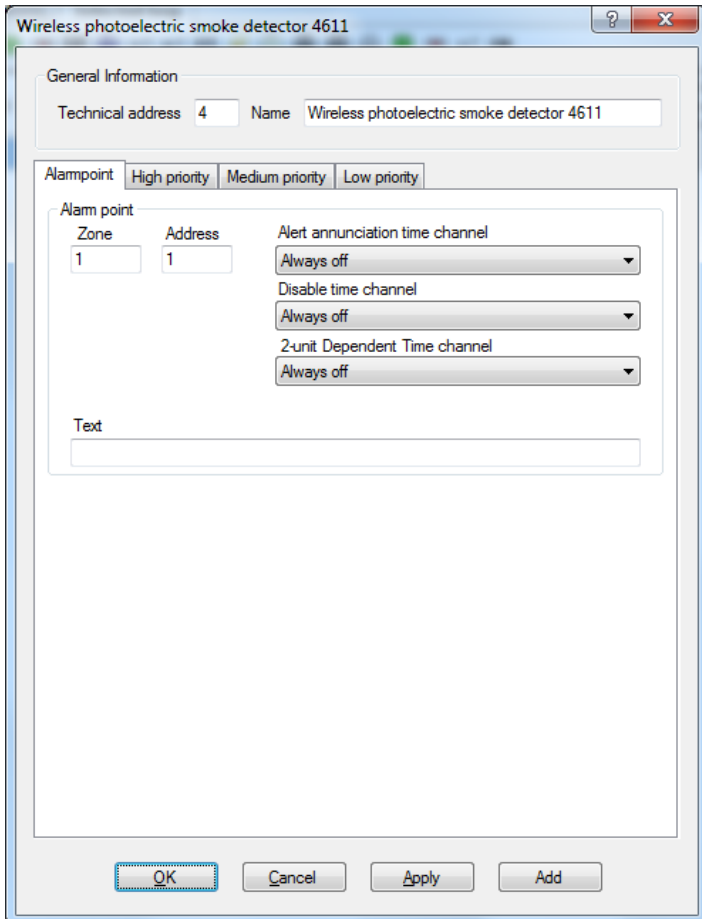

Each wireless unit also has to be programmed via EBLWin regarding presentation number (Zone-Address), alarm text, and so on. Control expressions for the sounder (high, medium and/or low priority) have to be programmed (wireless detector only).

Example: The Base station's com loop address is 012.

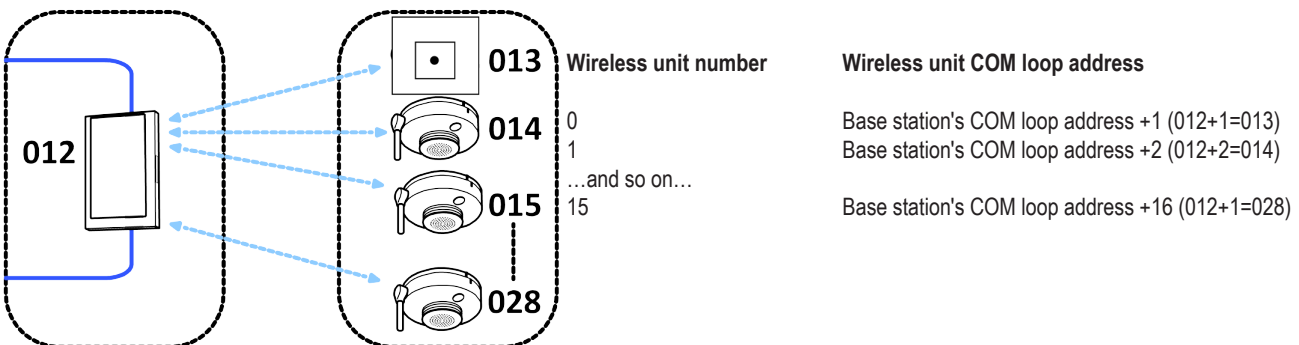

4.6. SET THE WIRELESS UNIT ADDRESS

Due to static electricity, it is not recommended to use any conductive tool, for example a metal screw driver, to set the DIL-switches.

Each base station can support up to 16 wireless units.
 The wireless unit address (0-15) have to be set for each unit respectively.

The wireless units address, set with the DIL switches, is always 0 for the first unit connected to a base station. All wireless units have to be in sequence.

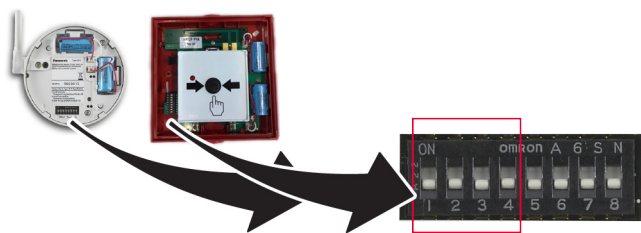

0 = OFF 1 = ON

Address	Switch 1	Switch 2	Switch 3	Switch 4
0	0	0	0	0
1	0	0	0	1
2	0	0	1	0
3	0	0	1	1
4	0	1	0	0
5	0	1	0	1
6	0	1	1	0
7	0	1	1	1
8	1	0	0	0
9	1	0	0	1
10	1	0	1	0
11	1	0	1	1
12	1	1	0	0
13	1	1	0	1
14	1	1	1	0
15	1	1	1	1

After change of address a power reset is required. Disconnect and re-connect both batteries.

4.7. SET THE TRANSMISSION CHANNEL

Due to static electricity, it is not recommended to use any conductive tool, for example a metal screw driver, to set the DIL-switches.

See section 3.1.1. TRANSMISSION CHANNEL (0-3) on page 7.

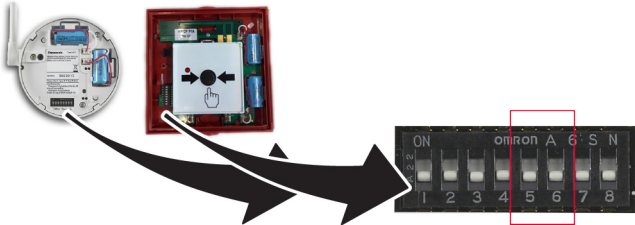

0 = OFF 1 = ON

Transmission channel	Switch 5	Switch 6
0	0	0
1	0	1
2	1	0
3	1	1

After change of transmission channel a power reset is required. Disconnect both batteries for 2 seconds and reconnect them again.

4.8. REGISTER A WIRELESS UNIT

Due to static electricity, it is not recommended to use any conductive tool, for example a metal screw driver, to set the DIL-switches.

It is recommended to do the registration procedure as close as possible to the final mounting position of the wireless units respectively.

See section [3.1.1. TRANSMISSION CHANNEL \(0-3\)](#) on page 7 for more information.

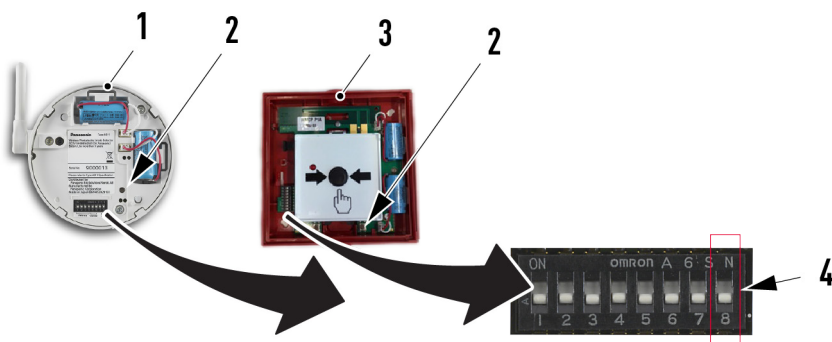

1. Wireless detector – open
2. Registration button
3. Wireless manual call point – open
4. DIL switch 8. ON = Register

- a) Set the base station to “Register” according to section [7.6. SET TO REGISTER MODE](#) on page 39.
- b) Set the DIL switch 8 (4) to ON.
- c) Mount and connect two pieces of battery 4612. See illustration above.
- d) Press the registration button (2).
- e) End the “Register mode” in the CIE for the correct base station.
See section [7.6. SET TO REGISTER MODE](#) on page 39 for the base station.
- f) Verify the registration according to section [4.8.1. CHECK REGISTRATION](#) on page 21.

4.8.1. CHECK REGISTRATION

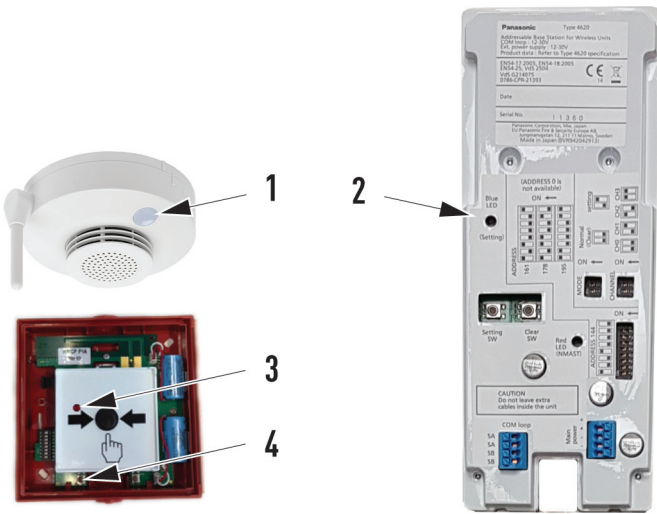

1. Detector LED and signal check button
2. Blue LED
3. Manual call point LED
4. Manual call point signal check button

If the registration is OK:

- The Blue LED (2) on the base station is flashing 3 times.
- The Detector LED (1) / Manual call point LED (3) is flashing 3 times and the detector sounder beeps one time.
- If the registration is OK, plug the wireless detector in its base.

If the registration is not OK:

- The Blue LED (2) on the base station is not flashing.
- The Detector LED (1) / Manual call point LED (3) is not flashing and there is no sound.
- The wireless detector and/or base station have to be moved to another position and/or replace the batteries, before a new registration procedure can be started. See section [BATTERIES, TYPE NUMBER 4612](#) on page 15.
- If the position of the base station is changed, all detectors are affected. The registration procedure has to be repeated for all wireless units.

4.9. SET TO UNREGISTER MODE

One registered wireless unit can be individually deregistered.

All wireless units registered in one base station can be collectively cancelled in that base station.

See section 3.1.1. TRANSMISSION CHANNEL (0-3) on page 7 for more information.

4.9.1. UNREGISTER ONE WIRELESS UNIT

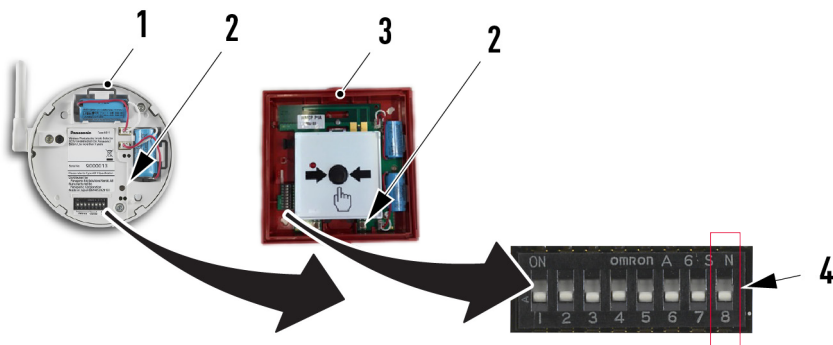

1. Wireless detector – open
2. Registration button
3. Wireless manual call point – open
4. DIL switch 8. OFF = Unregister

- a) Set the base station to “Unregister” according to section 7.7. SET TO UNREGISTER MODE on page 40.
- b) Set the Detector DIL switch 8 (4) to position OFF.
- c) Press the registration button.
- d) Verify the deregistration according to section 4.8.1. CHECK REGISTRATION on page 21.
- e) End the “Unregister mode” in the CIE for the correct base station. See section 7.7. SET TO UNREGISTER MODE on page 40 for the base station.

4.9.2. UNREGISTER ALL WIRELESS UNITS

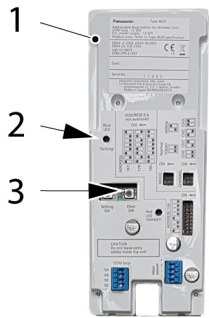

1. Addressable Base station – open
2. Blue LED
3. Clear button

- a) Set the base station to “Unregister” according to section [7.7. SET TO UNREGISTER MODE](#) on page 40.
- b) Press the Clear button (3) on the base station for 5 seconds.
- c) If the deregistration is OK - The Blue LED (2) on the base station is flashing 3 times.
- d) The blue LED (2) turns off and the base station restarts. When communication between the CIE and the base station has been established again, the CIE will set the base station to unregister mode.
- e) End the “Unregister” mode in the CIE for the correct base station. See section [7.7. SET TO UNREGISTER MODE](#) on page 40 for the base station.

4.10. MANUAL SIGNAL CHECK

When the wireless system is working in "normal" mode, the communication between the base station and a wireless units can be checked as follows:

- a) Press the Signal check button on the wireless unit. The detector LED is flashing for 5 seconds.
 - b) Check the wireless unit LED after those 5 seconds:
- If the LED is flashing 3 times (1s ON/0.5s OFF) it is indicating that the wireless unit communicates with its base station and the EN54-25 requirements are fulfilled.

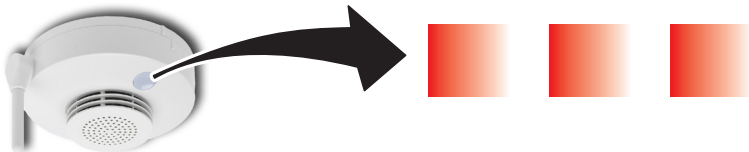

- If the LED is flashing 2 times x 3 is indicating that the wireless unit communicates with its base station but the EN54-25 requirements are not fulfilled.



- If the LED is flashing 3 times (0.25s ON/1.25s OFF) it is indicating that the transmission signal is too low. The wireless unit and/or the base station have to be moved to another position.



- If the LED is not flashing (OFF) it is indicating that the wireless unit is not communicating.

5. WIRELESS MANUAL CALL POINT 4614

5.1. BASIC INFORMATION

The Wireless manual call point is used for manual actuation of a fire alarm. The actuation of a fire alarm is indirect (type B). To operate the manual call point the glass element is pressed until it is broken and then the push button is pressed. This will generate a fire alarm in the CIE.

Inside the Wireless manual call point there is a tamper switch for "open door signal". If the WMCP door is opened, the WMCP will give a fault message in the CIE.

The fault message is the same as for the wireless detector:

Fault: Detector xxx-xx / yyyyyy removed

The unit is intended for indoor use and in dry premises.

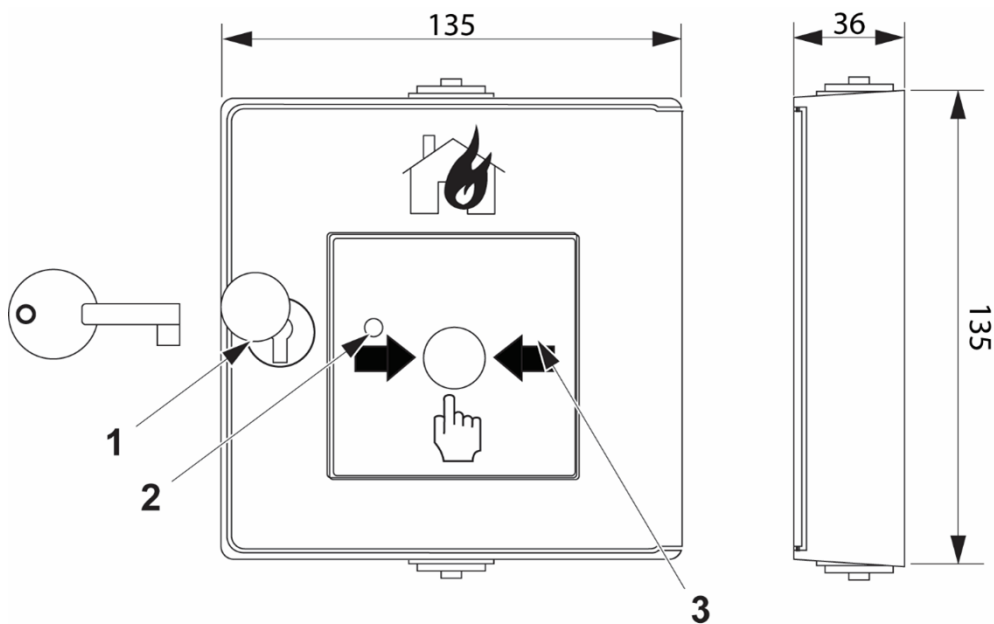

(Measures in mm)

1. Key hole
2. LED
3. Push button

BATTERIES, TYPE NUMBER 4612

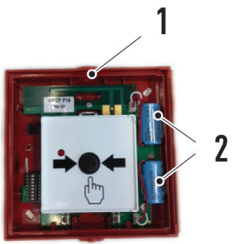

1. Wireless manual call point open
2. Batteries

The Wireless manual call point is powered by two pieces of supplied 3 V Lithium batteries. A battery voltage less than 2.8 V will generate a “battery” fault in the CIE. The manual call point will turn off the wireless signal when the battery voltage is less than 2.3 V, since the function cannot be guaranteed at such a low voltage. A “no reply” fault will then be generated in the CIE. Available as spare part.

The batteries (4612) has six years of service life used in 4614, in normal operation.

When replacing the batteries, remove both batteries for 2 seconds to force a restart of the manual call point. (The battery fault is latched so a restart is necessary to clear the fault.)

5.2. FIRE ALARM

To operate the manual call point the glass element is pressed until it is broken and then the push button is pressed. This will generate a fire alarm in the CIE. The CIE will send a message to turn on the indication LED on the Wireless manual call point.

5.3. SET THE COM LOOP ADDRESS - EBLWin PROGRAMMING

Each Wireless Manual call points takes one COM loop address, or Technical address, in EBLWin. The WMCP address will be the base Station's COM loop address +1, +2, up to +16.

All wireless units have to be in sequence.

Each Wireless manual call point also has to be programmed via EBLWin regarding presentation number (Zone-Address), alarm text, and so on.

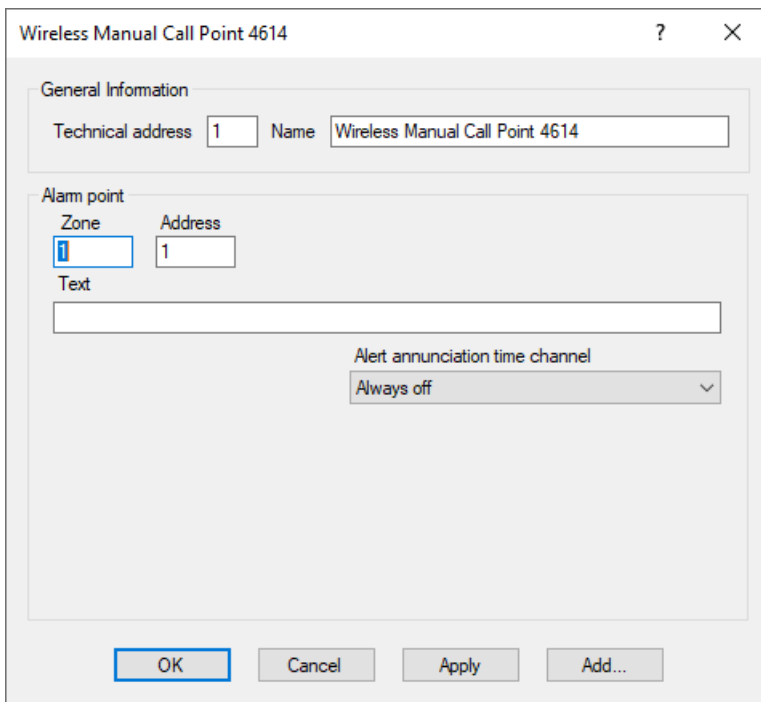

EBLWin dialog box "Wireless manual call point 4614."

Example: The Base station's com loop address is 012.

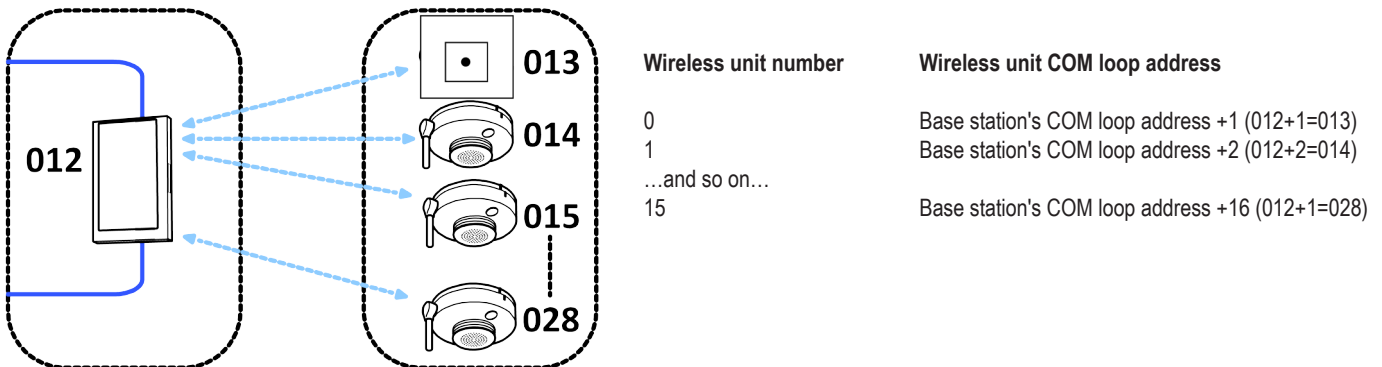

5.4. SET THE WIRELESS MANUAL CALL POINT ADDRESS

See section [4.6. SET THE WIRELESS UNIT ADDRESS](#) on page 18.

5.5. SET THE TRANSMISSION CHANNEL

See section [4.7. SET THE TRANSMISSION CHANNEL](#) on page 19.

5.6. REGISTER A WIRELESS MANUAL CALL POINT

See section [4.8. REGISTER A WIRELESS UNIT](#) on page 20.

5.7. SET TO UNREGISTER MODE

See section [4.9. SET TO UNREGISTER MODE](#) on page 22.

5.8. MANUAL SIGNAL CHECK

See section [4.10. MANUAL SIGNAL CHECK](#) on page 24.

6. WIRELESS LOCAL ALARM ACKNOWLEDGE UNIT 4645

The Wireless Local Alarm Acknowledge Unit (WLA AU) is a device communicating via the COM loop. Install the WLA AU in a room or other area together with a smoke detector and a sounder base.

When the detector detects smoke there will be a local alarm with sound from the sounder base and a lit LED in the WLA AU. If the button is pressed (acknowledged) within 30 seconds (or other programmed time) the sounder stops and the alarm will stay local for another 3 minutes (or other programmed time). If the button is not pressed a real fire alarm will be activated.

If the smoke that generated the alarm is removed (e.g. by opening a window) within 3 minutes (or other programmed time) the alarm is reset. If not a real fire alarm will be activated.

Inside the Wireless local alarm acknowledge unit there is a tamper switch for "open door signal". If the WLA AU door is opened, the WLA AU will give a fault message in the CIE.

The fault message is the same as for the wireless detector:

Fault: Detector xxx-xx / yyyyyy removed

The unit is intended for indoor use and in dry premises.

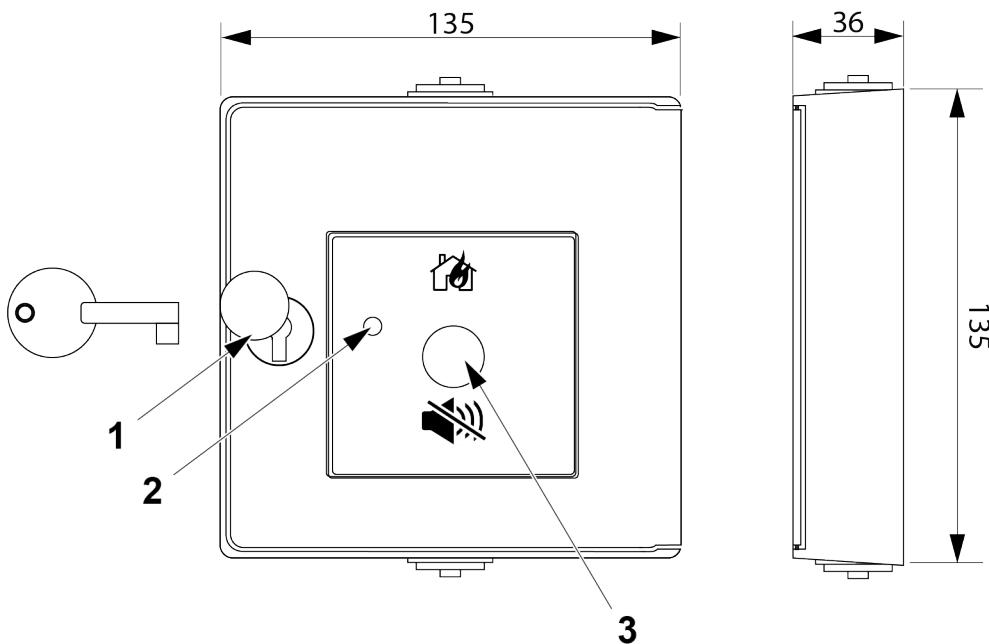

(Measures in mm)

1. Key hole
2. LED
3. Push button

BATTERIES, TYPE NUMBER 4612

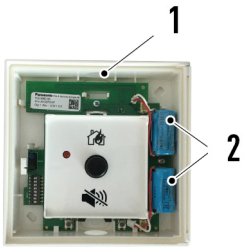

1. Wireless manual call point open
2. Batteries

The Wireless local alarm acknowledge unit is powered by two pieces of supplied 3 V Lithium batteries. A battery voltage less than 2.8 V will generate a “battery” fault in the CIE. The local alarm acknowledge unit will turn off the wireless signal when the battery voltage is less than 2.3 V, since the function cannot be guaranteed at such a low voltage. A "no reply" fault will then be generated in the CIE.

Available as spare part.

The batteries (4612) has six years of service life used in 4614, in normal operation.

When replacing the batteries, remove both batteries for 2 seconds to force a restart of the local alarm acknowledge unit. (The battery fault is latched so a restart is necessary to clear the fault.)

6.1. FIRE ALARM

When one of the detectors in the LAA zone goes into alarm the AA Process starts and the acknowledgement period is activated. During the acknowledgement period, (A Period=10-120 sec. -- programmable via EBLWin), the sounder of the LAA zone sounds and the LED on the LAAU and the detectors are lit. The alarm can be acknowledged (up to three times = 3 x 3 min. -- programmable via EBLWin), by pressing the button located on the wireless LAAU. When the button is pressed, the LED on the LAAU starts flashing. It can take up to 10 seconds before the local sounders stop sounding.

If the button is not pressed during the A Period a normal fire alarm will be activated and send a signal to the fire brigade and emergency warning system.

Acknowledging the alarm will silence the local sounder and activate the investigation period (I Period =1-9 min. -- programmable via EBLWin). At the end of the investigation period, if the alarm still exists, a normal fire alarm will be activated.

The AA Process ends if all the detectors in the LAA zone becomes normal again (goes below its fire alarm level) during the I Period.

For the multi detectors 4400I and 4400, the LAA function can in EBLWin be programmed to abort if the heat element of the detectors detect fire alarm.

LAAU information

LAA zone

Repeat counter

Abort on heat

The heat detection will then be at a static temperature of 56°C, corresponding to a class A1 heat detector. If the temperature exceeds the alarm threshold level, the investigation / acknowledge period will be immediately overridden and a normal fire alarm will be generated.

6.2. SET THE COM LOOP ADDRESS - EBLWin PROGRAMMING

Each Wireless local alarm acknowledge unit takes one COM loop address, or Technical address, in EBLWin. The WLA AU address will be the base station's COM loop address +1, +2, up to +16.

All wireless units have to be in sequence.

Each Wireless local alarm acknowledge unit also has to be programmed via EBLWin regarding LAA zone and Zone-Address.

The EBLWin WLA AU dialog box is originally set up to handle LAA zones with 5 detectors in each zone, but it is possible to connect all smoke detectors in a zone to the LAA zone by entering address 100 in EBLWin WLA AU dialog box.

In the example below the whole zone number 3 is connected to LAA zone number 1.

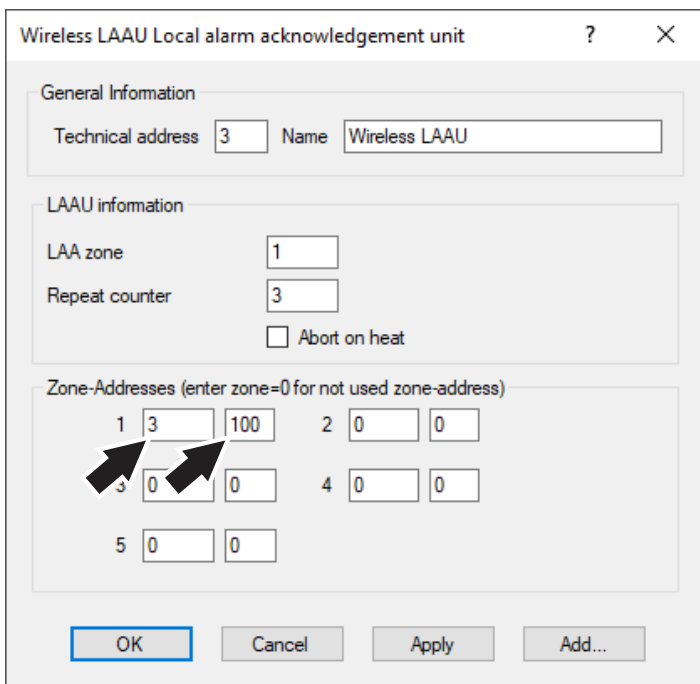

EBLWin dialog box "Wireless local alarm acknowledge unit 4645.

Example: The Base station's com loop address is 012.

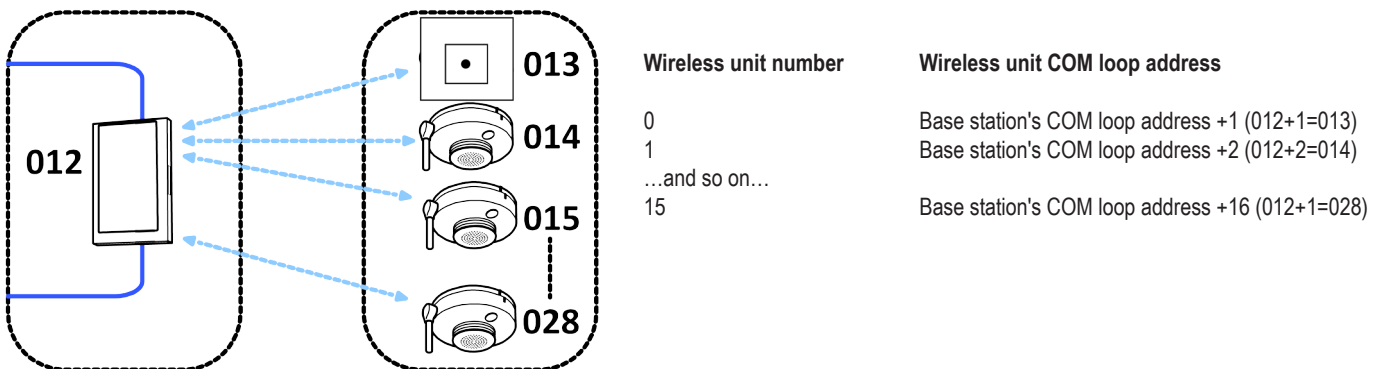

6.3. SET THE WIRELESS LOCAL ALARM ACKNOWLEDGE UNIT

See section [4.6. SET THE WIRELESS UNIT ADDRESS](#) on page 18.

6.4. SET THE TRANSMISSION CHANNEL

See section [4.7. SET THE TRANSMISSION CHANNEL](#) on page 19.

6.5. REGISTER A WIRELESS LOCAL ALARM ACKNOWLEDGE UNIT

See section [4.8. REGISTER A WIRELESS UNIT](#) on page 20.

6.6. SET TO UNREGISTER MODE

See section [4.9. SET TO UNREGISTER MODE](#) on page 22.

6.7. MANUAL SIGNAL CHECK

See section [4.10. MANUAL SIGNAL CHECK](#) on page 24.

7. ADDRESSABLE BASE STATION FOR WIRELESS UNITS 4620

7.1. BASIC INFORMATION

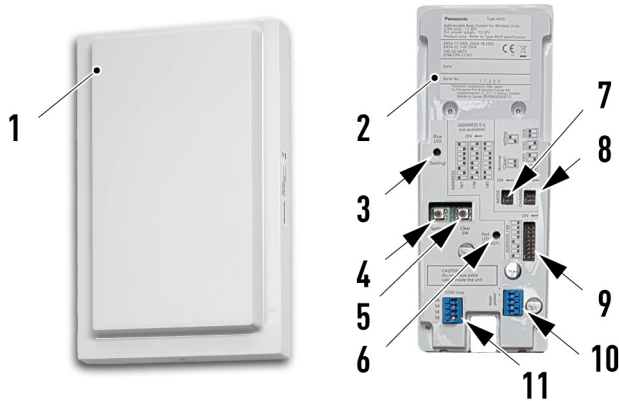

1. Cover
2. Base station – open
3. Blue LED
4. Setting button (Register)
5. Clear button (Unregister)
6. Red LED
7. Mode DIL
8. Channel DIL
9. Address DIL
10. Main power terminal
11. COM loop terminal

The Addressable Base station for wireless units consists of a printed circuit board mounted in a cover (1).

It has two fast connector terminals for the COM loop (11) (in / out) and Main power (10).

See chapter [10. TECHNICAL DATA](#) on page 50.

Each base station can support up to 16 wireless units. Up to four base stations can be connected to each COM loop, including the SUB-loops.

It is recommended to mount the base station vertical, since the base station's two built-in antennas then will be in the most favorable position. The base station shall have a central place relative to the wireless units. Take into account various materials in the walls.

SHORT CIRCUIT ISOLATOR

As an extra feature, the base station has a built-in short circuit isolator that requires no separate COM loop address. Like any other short circuit isolator, it has to be given an individual sequence number in the COM loop A-direction when registered in EBLWin.

7.2. CONNECTIONS

The base station has two fast connector terminals. The Main power terminal (2) and the COM loop terminal (3).

Use connector wire \varnothing 0.6 – 1.2 mm (approximately 0.28 – 1.13 mm²).

If wire \varnothing 0.6 mm is used, the release button may have to be pushed when the wire is pressed into the connector.

- Main power: 24 V DC (in / out) respectively. Maximum 40 mA is required.
- COM loop: COM loop current consumption is max. 6 mA.

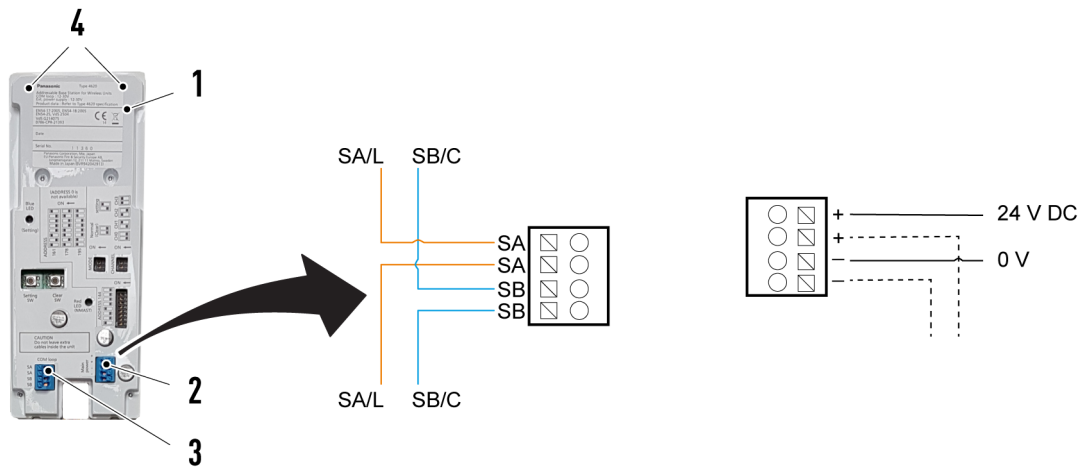

1. Base station – open
2. Main power terminal
3. COM loop terminal
4. Built in antennas

Connect the main power to the control unit or the External power supply 4466. Mount the base station as close as possible, a maximum of 3 meter cable is required.

It is recommended to have the cable inlets close to the Main power terminal (2) and the COM loop terminal (3), since the antennas (4) are located on the upper part of the base station. The antennas must not be hidden by cables.

7.3. SET THE COM LOOP ADDRESS - EBLWin PROGRAMMING

The base station has to have a COM loop address, 1-253. The base station is programmed via the PC program EBLWin. In an EBL system, up to four base stations can be connected to each COM loop, including the SUB-loops.

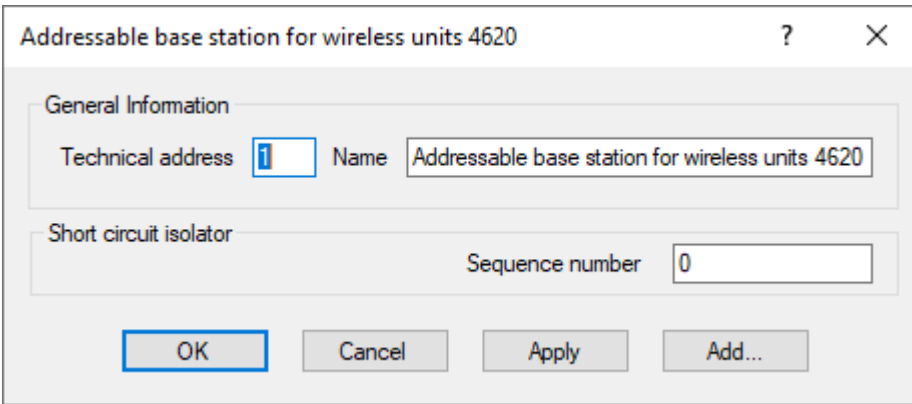

EBLWin dialog box for Addressable base station 4620

To be able to auto address the loop or connect the highest possible number of wireless units, the Wireless base stations 4620 must have address 144, 161, 178 or 195 .

Set the DIL-switches according to the illustration below.

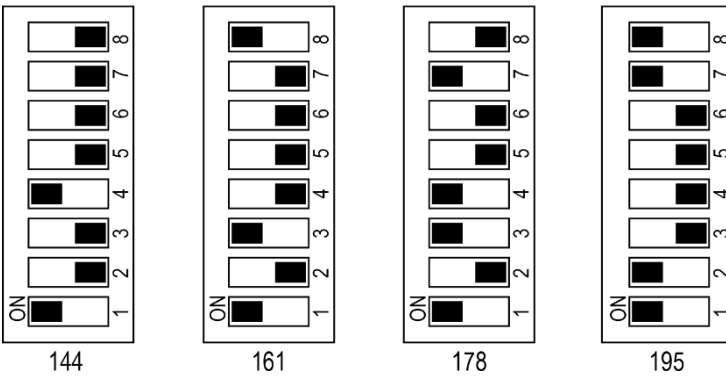

THE ADDRESS DIL-SWITCH ON THE BASE STATION

Due to static electricity, it is not recommended to use any conductive tool, for example a metal screw driver, to set the DIL-switches.

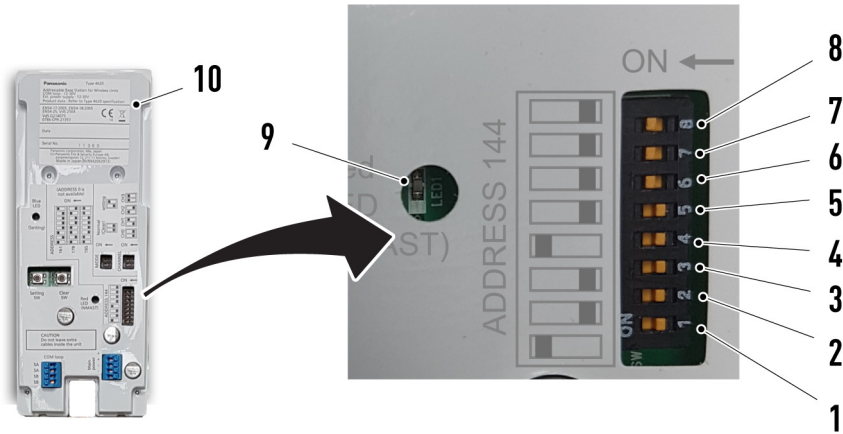

1. Address 128
2. Address 64
3. Address 32
4. Address 16
5. Address 8
6. Address 4
7. Address 2
8. Address 1
9. Red LED
10. Base station - open

- All switches (1-8) OFF = 0 NOTE! 0 is not a valid COM loop address.
 - Switch "8" ON = 1 (COM loop address 001.)
 - Switch "8" OFF and Switch "7" ON = 0+2 = 2 (COM loop address 002.)
 - Switch "8" ON and Switch "7" ON = 1+2 = 3 (COM loop address 003.)
- ...and so on...

Example: Switches "8", "7", "6", "5", "4", "3", "2" and "1" ON = 1+2+4+8+16+32+64+128 = Address 255. After the address setting the base station will do an automatic restart, indicated by the red LED (9) flashing 1 time.

7.4. SET THE TRANSMISSION CHANNEL

Due to static electricity, it is not recommended to use any conductive tool, for example a metal screw driver, to set the DIL-switches.

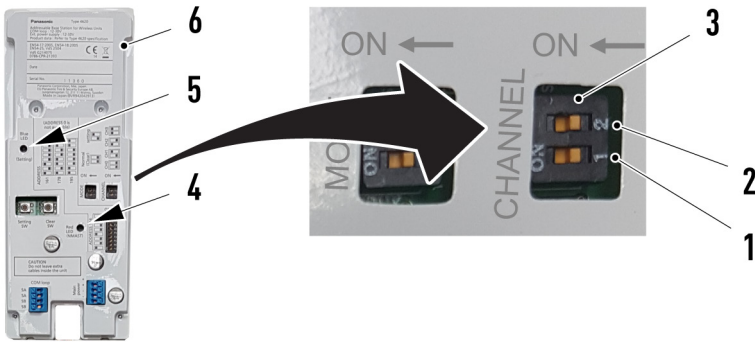

1. Channel switch 1
2. Channel switch 2
3. Channel DIL
4. Red LED
5. Blue LED
6. Base station – open

0 = OFF 1 = ON

Transmission channel	Switch 1	Switch 2
0	0	0
1	0	1
2	1	0
3	1	1

After changing transmission channel the blue LED (5) will blink 3 times and then the base station will do a restart. The restart is indicated by the red LED (4) blinking 1 time.

After changing transmission channel, all data about any registered detector / manual call point will be erased. All the wireless units have to be registered on the new transmission channel.

7.5. SET TO INSTALL MODE

Normally the base station communicates with its wireless units every 2 minutes.

In "Install mode" the communication will be every 5 seconds. This mode can be used while collecting data for the sniffer and the log, so that the data will be collected faster than normally.



1. Base station
2. Blue LED

- a) Set the base station (1) to "Install mode" from the CIE menu.
 - In EBLOne; go to menu > >
 - In EBL512 G3; go to menu H5/A8
 - In EBL128; go to menu H5/A9
- b) The change of mode is confirmed by the blue LED (2), which is lit with a fixed light.

END THE "INSTALL MODE"

- c) After operation, end the "Install mode" in the CIE for the correct base station.

If the base station is set in "Install mode" from the CIE it remains in this mode until ended from the CIE or automatically after 10 hours.

In "Install mode" the wireless units will not work normally. The fire alarm cannot be activated and the manual signal check function will not work.

7.6. SET TO REGISTER MODE

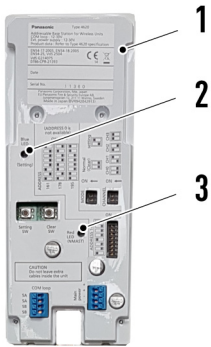

1. Base station
2. Blue LED
3. Red LED

- a) Set the base station (1) to “Register mode” from the CIE menu.
 - In EBLOne; go to menu > >
 - In EBL512 G3; go to menu H5/A8
 - In EBL128; go to menu H5/A9
- b) The change of mode is confirmed by the blue LED (2), which is lit with a fixed light.

END THE “REGISTER MODE”

- c) When the wireless units are registered, end the “Register mode” in the CIE for the correct base station:
- d) This is confirmed by the blue LED (2), which is turned off.
- e) The red LED (3) flashes 1 time, indicating the restart of the base station.
- f) The base station will now be synchronized with all its wireless units. This can take up to 5 minutes.
- g) When the synchronization is ready, correct if there are any faults in the CIE.

If the base station is set in register mode from the CIE it remains in this mode until ended from the CIE or automatically after 10 hours.

7.7. SET TO UNREGISTER MODE

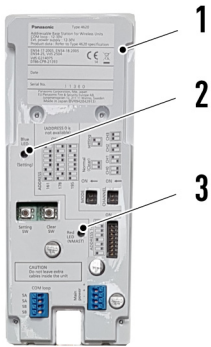

1. Base station
2. Blue LED
3. Red LED

- a) Set the base station (1) to “Unregister” from the CIE menu.
 - In EBLOne; go to menu > >
 - In EBL512 G3; go to menu H5/A8
 - In EBL128; go to menu H5/A9
- b) The change of mode is confirmed by the blue LED (2), which is lit with a fixed light.

END THE “UNREGISTER MODE”

- c) When the wireless units are deregistered, end the “Unregister mode” in the CIE for the correct base station:
- d) This is confirmed by the blue LED (2), which is turned off.
- e) The red LED (3) flashes 1 time, indicating the restart of the base station.
- f) The base station will now be synchronized with all its wireless units. This can take up to 5 minutes.
- g) When the synchronization is ready, correct if there are any faults in the CIE.

If the base station is set in Unregister mode from the CIE it remains in this mode until ended from the CIE or automatically after 10 hours.

7.8. MODE DIL

The function of the Mode DIL (3) can be used for registration of wireless units. The base station does not have to be connected to the CIE. Only 24 V connections for the base station are required. Therefore, this function is ideal when the registration takes place off site.

Due to static electricity, it is not recommended to use any conductive tool, for example a metal screw driver, to set the DIL-switches.

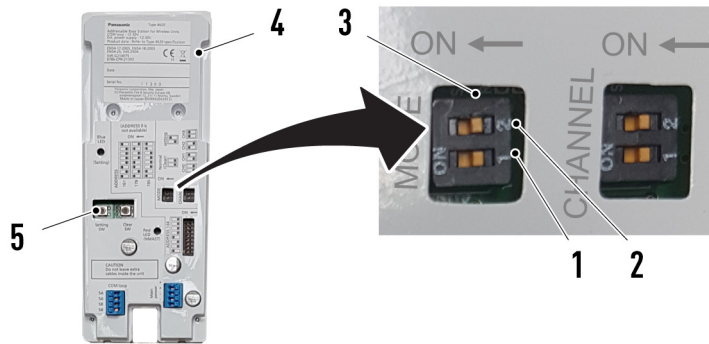

1. Mode switch 1
2. Mode switch 2
3. Mode DIL
4. Base station – open
5. Setting button

0 = OFF 1 = ON

MODE	Mode switch 1	mode switch 2
Normal mode	0	0
setting mode	0	1

7.8.1. REGISTER WITH MODE DIL

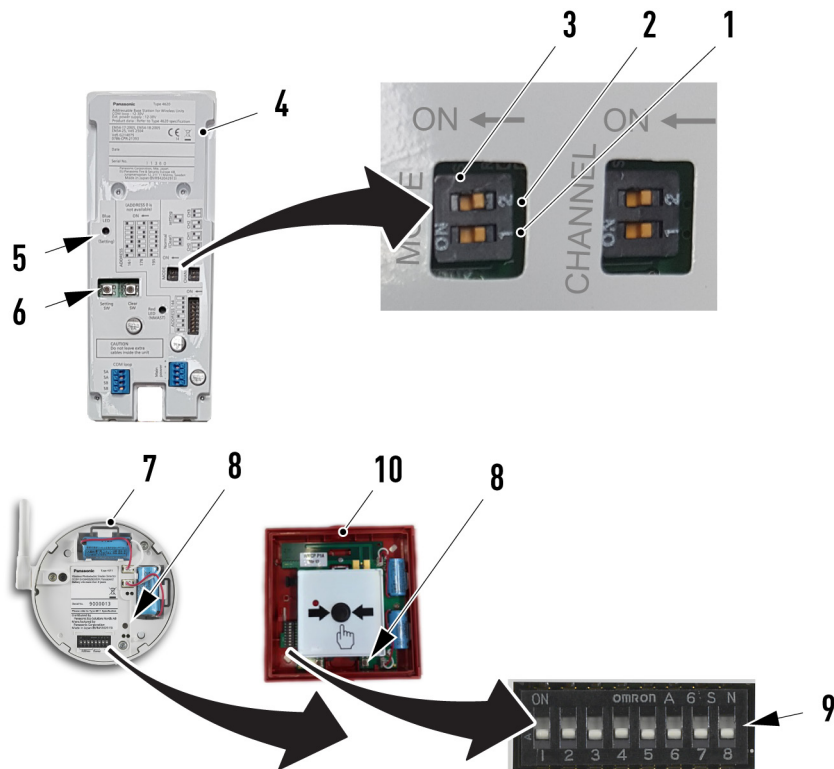

1. Mode switch 1
2. Mode switch 2
3. Mode DIL
4. Base station – open
5. Blue LED
6. Setting button
7. Wireless detector – open
8. Registration button
9. DIL switch 8
10. Wireless manual call point – open

- a) Connect 24 V to the base station according to section [7.2. CONNECTIONS](#) on page 34.
- b) Set the transmission channel for the base station according to [7.4. SET THE TRANSMISSION CHANNEL](#) on page 37.
- c) Set the transmission channel for the wireless units according to [4.7. SET THE TRANSMISSION CHANNEL](#) on page 19.
- d) Set the address for the wireless units according to [4.6. SET THE WIRELESS UNIT ADDRESS](#) on page 18.
- e) Set the Mode DIL (3) to Setting mode. See table in section [7.8. MODE DIL](#) on page 41.
- f) Set the DIL switch 8 (9) to ON.
- g) Mount and connect one piece of battery 4612 into the wireless units.
- h) Press and hold the Setting button (6) in the base station. The blue LED (5) turns on.
- i) Press the Registration button (8) on the wireless unit.
- j) Verify the registration according to section [4.8.1. CHECK REGISTRATION](#) on page 21.
- k) Release the Setting button (6). The blue LED (5) turns off.
- l) Disconnect the battery from the wireless unit.
- m) When all wireless units have been registered, disconnect 24 V from the base station.

8. WIRELESS SNIFFER 4613

8.1. BASIC INFORMATION

As a help during planning, installation and commissioning, a Wireless sniffer can be used to check if the signals between a base station and all its wireless units are Good, Acceptable or Bad.

Also the background noise can be checked. It is highly recommended to do a check on site, prior to the final installation.



The sniffer is a USB device with an antenna. The device is plugged in a PC (laptop) and is used together with the EBLsniffer PC program. The PC program is used on site to check and present:

- The background noise.
- The signals between a base station and its wireless units.

Since the PC itself can affect the sniffer, it is highly recommended to use a USB extension cable between the PC and the sniffer when checking the background noise. The cable should be at least 2 meters. The cable is not included with the sniffer.

The sniffer needs drivers. Download the drivers from our homepage and see MEW01308 for installation instructions.

During installation of the sniffer program, select desired frequency:

- European standard: 868 / 869 MHz
- Australian standard: 916.1 / 916.8 MHz

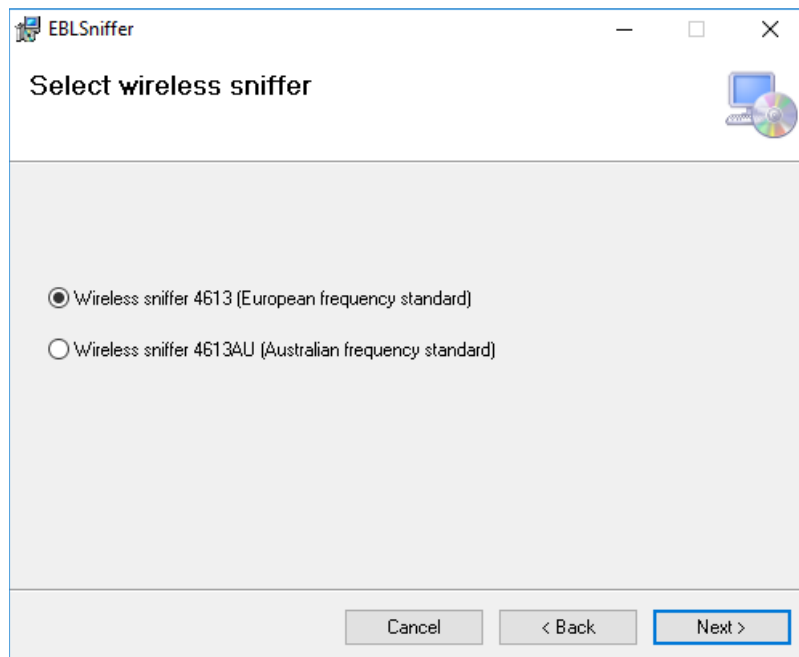

To use the program in the PC, an EBLWin key 5094 is required.

8.2. CHECK THE BACKGROUND

The background noise is caused by other units than the wireless units and the base stations. If the signal levels on the same frequencies that are used for the wireless units are too high, they can affect the wireless units.

- Set up the EBLsniffer PC program, with an USB extension cable between the PC and the sniffer. See section [8.1. BASIC INFORMATION](#) on page 43.
- Click the **Setup/Open serial port**. Select any channel. It doesn't matter which master channel or sub channel that is open. Background check only uses one sniffer that scans the whole frequency band of interest.
- Click the **Check background/Start** button. The Check background tab opens.
- Click the **Check background/Stop** button. The check will be stopped.
- Click the **Save** button. The diagram will be saved as a .jpg image.

Example:

In this example the blue line is beneath the orange line. The background noise is acceptable. The % value shall be less than 50% and the lower the better.

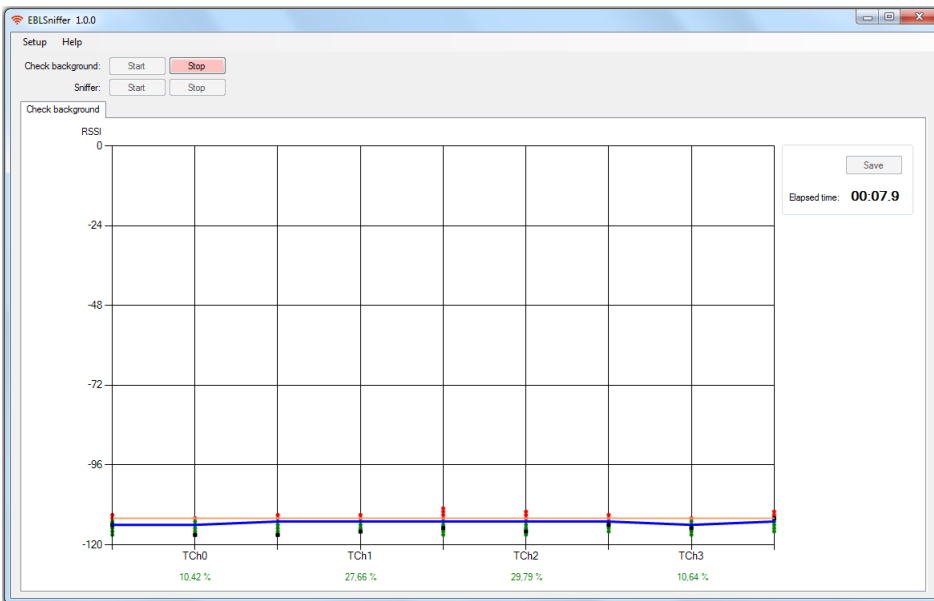

Red dots: Radio signal levels that could be a potential danger for the wireless units and base station.

Green dots: Radio signal levels that are not a potential danger for the wireless units and base station.

Blue line: Shows the red and green dots' average value and shall be on or beneath the orange line.

(The blue line will never be shown beneath the -120 line.)

8.3. CHECK THE COMMUNICATION

Check the communication value of the base station and the wireless units after installation. The sniffer helps to optimize the position of the wireless units.

- Set up the EBLsniffer PC program.
- Set the base station to "Install mode" according to section 7.5. SET TO INSTALL MODE on page 38.
- Click the **Setup/Open serial port** and choose which transmission channel (TCh0-TCh3) you want to listen to. Designate a sniffer to the selected transmission channel. (Optional: If you want to listen to backup channels, designate a sniffer to each backup channel you want to listen to.)
- Click the **Sniffer/Start** button. The sniffer and log tabs opens. Wait for communication.
- Click the **Sniffer/Stop** button. The check will be stopped.
- Click the **Save** button. The diagram will be saved as a .jpg image.

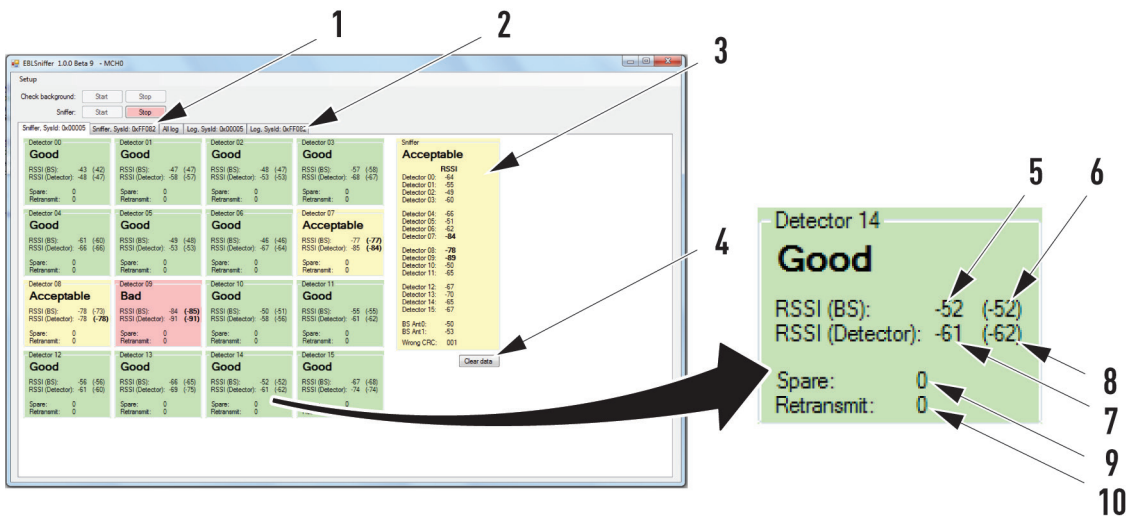

Example: Two systems, both communicating on transmission channel 0. The Tab for system "0x00005" is open.

- Sniffer tab
- Log tab
- Sniffer square RSSI: The signal level in the sniffer for each wireless unit and the base station.
- Clear data: Clear all wireless units and sniffer data and resets average. Click when wireless unit is moved to new position.
- Latest value of RSSI (BS): The signal level in the base station
- Average value of RSSI (BS): The signal level in the base station
- Latest value of RSSI (wireless units): The signal level in the wireless unit
- Average value of RSSI (wireless units): The signal level in the wireless unit
- Spare: Number of messages sent in 'Spare' frame
- Retransmit: Number of retransmitted messages

WIRELESS UNITS SQUARE - EXPLANATION OF THE COLOURS

Good: Both the average value for the base station and the detector are over -75. EN54-25 is fulfilled.	Acceptable: At least one average value for the base station or a detector is between -90 and -75. EN54-25 is not fulfilled.	Bad: At least one average value for the base station or a detector are beneath -90. Change positions of base station and/or detector.	All data is not received yet or the detector stopped answering (nothing received in 5 minutes).
---	--	--	---

This means that if EN54-25 shall be fulfilled, all wireless units squares have to be green.

SNIFFER SQUARE - EXPLANATION OF THE COLOURS

Good: No RSSI value beneath -75	Acceptable: No RSSI value beneath -90.	Bad: One RSSI value beneath -90.	All data is not received yet or the detector stopped answering (nothing received in 5 minutes).
---	--	--	---

These values show if the sniffer position, compared with the wireless units and base station positions, is good, acceptable or bad. If necessary, move the sniffer to an acceptable or good position.

LOG TAB

The "Log tab" for a system shows the communication between the base station and the wireless units. This log and the information shown are primarily intended for research and development purposes.

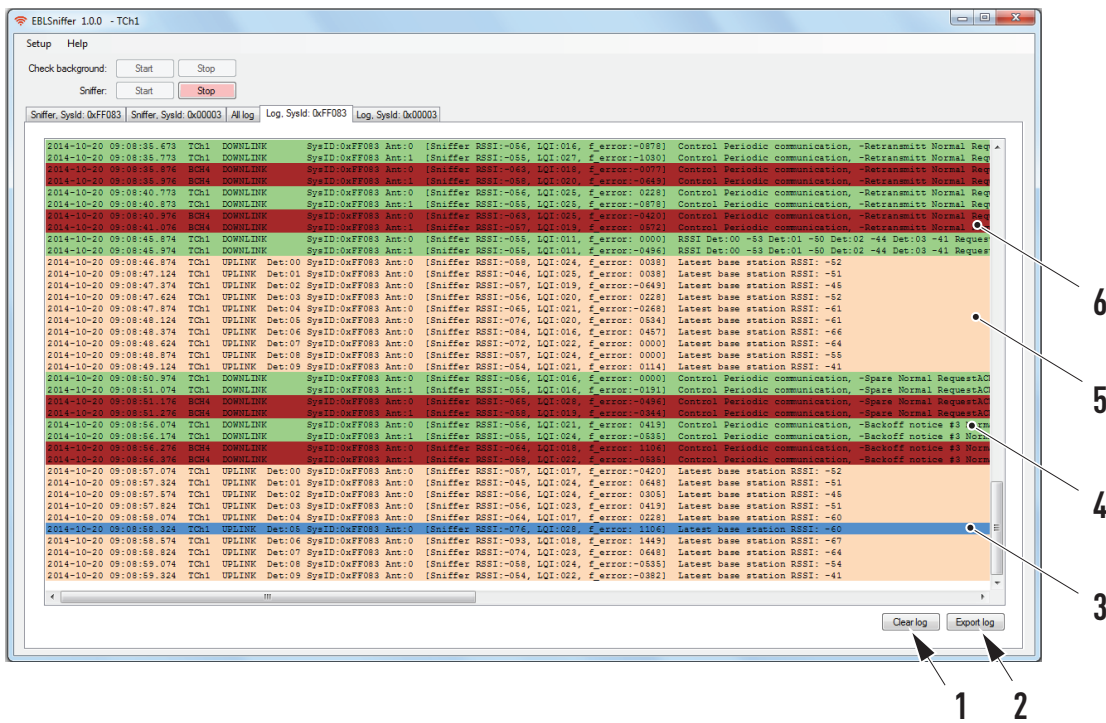

1. Clear log: The log will be cleared.
2. Export log: The log will be exported to Excel. **NOTE!** Excel 2007 or later is required.
3. Blue row: Shows the selected event.
4. Green row: (DOWNLINK) shows the communication from the base station to one or several wireless unit.
5. Peach row: (UPLINK) shows the communication from the wireless units to the base station.
6. Brown row: (DOWNLINK or UPLINK) shows the communication on sub channels.

In case of needed support and analyses of the log, do as follows:

- a) Choose the Log tab.
- b) Click on Export log. The sniffer program will create an Excel document.
- c) Save the Excel document: Choose File/Save as.

9. COMMISSIONING THE WIRELESS SYSTEM

This chapter describes the correct sequence to install, set and check your wireless system.

NOTE! Make sure to read the complete technical description before commissioning the system.

PREPARATIONS AND MOUNTING

- a) Check the background noise with the Wireless sniffer according to section 8.2. CHECK THE BACKGROUND on page 45.
- b) Mount the base station on the wall. See section 3.1.7. TRANSMISSION RANGE on page 12.
- c) Mount the bases for the wireless smoke detectors in the ceiling, so that the detectors will have the antenna in the direction towards the base station.
- d) Mount the wireless manual call points on the wall.
- e) Mount the wireless local alarm acknowledge unit on the wall.

CONNECTIONS

- f) Set the transmission channel for the base station according to section 7.4. SET THE TRANSMISSION CHANNEL on page 37. Also read section 3.1.1. TRANSMISSION CHANNEL (0-3) on page 7.
- g) Connect the base station to the COM loop and 24 V DC according to section 7.2. CONNECTIONS on page 34.

PROGRAMMING IN EBLWIN AND DOWNLOADING SSD

- h) Do the programming in EBLWin. Set the COM loop address for the base station according to section 7.3. SET THE COM LOOP ADDRESS - EBLWin PROGRAMMING on page 35 and for the wireless units according to 4.5. SET THE COM LOOP ADDRESS - EBLWin PROGRAMMING on page 17.
- i) Download the Site Specific Data (SSD) to the control unit.

REGISTER

- j) Set the base station to "Register mode" according to section 7.6. SET TO REGISTER MODE on page 39.
- k) Set the transmission channel for each wireless unit according to section 4.7. SET THE TRANSMISSION CHANNEL on page 19.
- l) Set the address for each wireless unit according to section 4.6. SET THE WIRELESS UNIT ADDRESS on page 18.
- m) Connect both batteries into the wireless units.
- n) Register all the wireless units that shall be registered to the same base station. Those units have the same transmission channel as the base station. Register according to 4.8. REGISTER A WIRELESS UNIT on page 20.
- o) Make sure to end the register mode for the base station according to 7.6. SET TO REGISTER MODE, c) to g).

CHECK

- p) Mount the detectors in their bases.
- q) Make a manual signal check according to section 4.10. MANUAL SIGNAL CHECK on page 24.
- r) Check the communication with the wireless sniffer according to section 8.3. CHECK THE COMMUNICATION on page 46.

TEST

- s) For information about how to set the detector in test mode, see Planning Instructions or Operating Instructions. It is possible to use test aerosol equipment for testing. For example "SOLO" or "Testfire".

10. TECHNICAL DATA

All current consumptions are valid by nominal voltage and by 25 °C.

TRANSMISSION DATA - VALID FOR 4611, 4613, 4614, 4620, AND 4645	
Transmission distance:	Up to 170 in open air. (EN54-25 fulfilled) Up to 250 in open air (EN54-25 not fulfilled)
Transmission / Modulation method	TDMA / FSK
Frequency band European standard:	868.6125MHz (Channel 0) 868.6375MHz (Channel 1) 868.6625MHz (Channel 2) 868.6875MHz (Channel 3) 869.3125MHz (Backup Channel 4) 869.3375MHz (Backup Channel 5) 869.3625MHz (Backup Channel 6) 869.3875MHz (Backup Channel 7)
Frequency band Australian standard:	916.1125MHz (Channel 0) 916.1375MHz (Channel 1) 916.1625MHz (Channel 2) 916.1875MHz (Channel 3) 916.8125MHz (Backup Channel 4) 916.8375MHz (Backup Channel 5) 916.8625MHz (Backup Channel 6) 916.8875MHz (Backup Channel 7)

WIRELESS PHOTOELECTRIC SMOKE DETECTOR – 4611	
Detector battery: Min. / Norm. / Max.	2.5 / 3 / 3.5 V DC Battery = 2 x 3 V Lithium battery, type 4612
Current consumption:	30 µA (Normal average)
Sensitivity:	3.5 - 4% /meter (Smoke density)
Sensitivity (obscuration; %/m) Detection cycle (sec.)	3.5 5.1 (but when over the fire alarm threshold level: 1.)
Sounder:	More than 85 dB/meter
Address:	0 - 15 (DIL-switch)
System:	Up to 16 wireless units (type 4611) per base stations (type 4620)
Material: Cover and Base: Body and Button:	ABS PC - Modified polycarbonate
Ambient temperature: Operating Storage	10 to +55 °C 15 to +60 °C (Without batteries)
Ambient humidity:	Maximum 95, % RH (Non condensing)
Ingress protection rating:	IP 50
Weight:	165 g (including batteries)
Size: Ø x H Antenna length	100 x 45 mm (antenna excluded) 55 mm
Colour:	White (10Y9/0.5, Munsell colour code).

WIRELESS MANUAL CALL POINT – 4614	
Manual call point battery: Min. / Norm. / Max.	2.5 / 3 / 3.5 V DC Battery = 2 x 3 V Lithium battery, type 4612
Current consumption:	30 µA (Normal average)
Address:	0 - 15 (DIL-switch)
System:	Up to 16 wireless units (type 4614) per base stations (type 4620)
Material:	FR ABS polycarbonate
Ambient temperature: Operating Storage	10 to +55 °C 15 to +60 °C (Without batteries)
Ambient humidity:	Maximum 95, % RH (Non condensing)
Weight:	250 g (including batteries)
Size: H x W x D	135 x 135 x 36 mm
Colour:	Red (RAL 3000)

WIRELESS LOCAL ALARM ACKNOWLEDGE UNIT – 4645	
Local alarm acknowledge unit battery: Min. / Norm. / Max.	2.5 / 3 / 3.5 V DC Battery = 2 x 3 V Lithium battery, type 4612
Current consumption:	30 µA (Normal average)
Address:	0 - 15 (DIL-switch)
System:	Up to 16 wireless units (type 4645) per base stations (type 4620)
Material:	FR ABS polycarbonate
Ambient temperature: Operating Storage	10 to +55 °C 15 to +60 °C (Without batteries)
Ambient humidity:	Maximum 95, % RH (Non condensing)
Weight:	250 g (including batteries)
Size: H x W x D	135 x 135 x 36 mm
Colour:	White (10Y9/0.5, Munsell colour code)

ADDRESSABLE BASE STATION FOR WIRELESS UNITS – 4620		
Voltage: Allowed Normal	External power supply 12-30 V DC 24 V DC	COM loop 12-30V DC 24V DC
Current consumption at normal voltage:	External power supply Max. 40 mA	COM loop 4.5 mA (max. 6)
Short circuit isolator	Built-in	
Address:	0 - 255 (DIL-switch)	
System:	Up to 16 wireless units (type 4611 / 4614) per base stations (type 4620)	
Material: Cover and Base:	ABS	
Ambient temperature: Operating Storage	10 to +55 °C 15 to +60 °C	
Ambient humidity:	Maximum 95, % RH (Non condensing)	
Ingress protection rating	IP 50	
Weight:	345 g (including batteries)	
Size: H x W x D	240 x 150 x 31 mm	
Colour:	White (10Y9/0.5, Munsell colour code)	

WIRELESS SNIFFER – 4613	
Connection	USB device
Ambient temperature: Operating Storage	10 to +55 °C 15 to +60 °C (Without batteries)
Ambient humidity:	Maximum 95, % RH (Non condensing)
Ingress protection rating	IP 50
Weight:	30 g (including batteries)
Size: H x W x D	23 x 14 x 190 mm
Colour:	Black

11. DECLARATION OF CONFORMITY

RED 2014/53/EU - Radio Equipment Directive. Download the Radio Equipment directive, <https://www.panasonic-fire-security.com>

NAME OF MANUFACTURER









For 4611 and 4620: Panasonic Corporation Eco Solutions Company Energy System Business Division System Components Business Unit (short PES SCBU)

For 4614: Panasonic Fire & Security Europe (short PFSEU).

For 4645: Panasonic Fire & Security Europe (short PFSEU).

TYPE OF EQUIPMENT

Wireless detector system; Wireless photoelectric smoke detector, type 4611; Wireless manual call point type 4614, Addressable Base station for wireless units, type 4620, and Wireless Local alarm acknowledge unit, type 4645.

 Български [Bulgarian]	С настоящото PES SCBU/PFSEU декларира, че това, типе 4611, Wireless manual call point, type 4614, Addressable Base station за wireless units, type 4620, и Wireless local alarm acknowledge unit, type 4645, е в съответствие със съществените изисквания и други приложими разпоредби на Директива 2014/53/ЕС.
 Český [Czech]	PES SCBU/PFSEU tímto prohlašuje, že tento Wireless detector system; Wireless photoelectric smoke detector, type 4611, Wireless manual call point, type 4614, Addressable Base station for wireless units, type 4620, a Wireless local alarm acknowledge unit, type 4645, je ve shodě se základními požadavky a dalšími příslušnými ustanoveními směrnice 2014/53/EU.
 Dansk [Danish]	Undertegnede PES SCBU/PFSEU erklærer herved, at følgende udstyr Wireless detector system; Wireless photoelectric smoke detector, type 4611, Wireless manual call point, type 4614, Addressable Base station for wireless units, type 4620, og Wireless local alarm acknowledge unit, type 4645, overholder de væsentlige krav og øvrige relevante krav i direktiv 2014/53/EU.
 Deutsch [German]	Hiermit erkläre PES SCBU/PFSEU, dass sich das Gerät Wireless detector system; Wireless photoelectric smoke detector, type 4611, Wireless manual call point, type 4614, Addressable Base station for wireless units, type 4620, und Wireless local alarm acknowledge unit, type 4645, in Übereinstimmung mit den grundlegenden Anforderungen und den übrigen einschlägigen Bestimmungen der Richtlinie 2014/53/EU befindet.
 Eesti [Estonian]	Käesolevaga kinnitab PES SCBU/PFSEU seadme Wireless detector system; Wireless photoelectric smoke detector, type 4611, Wireless manual call point, type 4614, Addressable Base station for wireless units, type 4620, ja Wireless local alarm acknowledge unit, type 4645, vastavust direktiivi 2014/53/EL põhinõuetele ja nimetatud direktiivist tulenevatele teistele asjakohastele sätetele.
 English	Hereby, PES SCBU/PFSEU, declares that this Wireless detector system; Wireless photoelectric smoke detector, type 4611, Wireless manual call point, type 4614, Addressable Base station for wireless units, type 4620, and Wireless local alarm acknowledge unit, type 4645, is in compliance with the essential requirements and other relevant provisions of Directive 2014/53/EU.
 Español [Spanish]	Por medio de la presente PES SCBU/PFSEU declara que el Wireless detector system; Wireless photoelectric smoke detector, type 4611, Wireless manual call point, type 4614, Addressable Base station for wireless units, type 4620, y Wireless local alarm acknowledge unit, type 4645, cumple con los requisitos esenciales y cualesquiera otras disposiciones aplicables o exigibles de la Directiva 2014/53/UE.
 Vlaams [Flemish]	Hierbij verklaart PES SCBU/PFSEU dat dit Wireless detector system; Wireless photoelectric smoke detector, type 4611, Wireless manual call point, type 4614, Addressable Base station voor wireless units, type 4620, en Wireless local alarm acknowledge unit, type 4645, voldoet aan de essentiële vereisten en andere relevante bepalingen van Richtlijn 2014/53/EU.
 Français [French]	Par la présente, le PSE SCBU/PFSEU déclare que ce Wireless detector system; Wireless photoelectric smoke detector, type 4611, Wireless manual call point, type 4614, Addressable Base station pour wireless units, type 4620, et Wireless local alarm acknowledge unit, type 4645, est conforme aux exigences essentielles et aux autres dispositions pertinentes de la directive 2014/53/UE.

<p>GR Ελληνική [Greek]</p>	<p>ΤΗΝ ΠΑΡΟΥΣΑ PES SCBU/PFSEU ΔΗΛΩΝΕΙ ΟΤΙ Wireless detector system; Wireless photoelectric smoke detector, type 4611, Wireless manual call point, type 4614, Addressable Base station for wireless units, type 4620, ΚΑΙ Wireless local acknowledge unit, type 4645, ΣΥΜΜΟΡΦΩΝΕΤΑΙ ΠΡΟΣ ΤΙΣ ΟΥΣΙΩΔΕΙΣ ΑΠΑΙΤΗΣΕΙΣ ΚΑΙ ΤΙΣ ΛΟΙΠΕΣ ΣΧΕΤΙΚΕΣ ΔΙΑΤΑΞΕΙΣ ΤΗΣ ΟΔΗΓΙΑΣ 2014/53/ΕΕ.</p>
<p>IT Italiano [Italian]</p>	<p>Con la presente PES SCBU/PFSEU dichiara che questo Wireless detector system; Wireless photoelectric smoke detector, type 4611, Wireless manual call point, type 4614 Addressable Base station for wireless units, type 4620, e Wireless local alarm acknowledge unit, type 4645, è conforme ai requisiti essenziali ed alle altre disposizioni pertinenti stabilite dalla direttiva 2014/53/UE.</p>
<p>LV Latviski [Latvian]</p>	<p>Ar šo PES SCBU/PFSEU deklarē, ka Wireless detector system; Wireless photoelectric smoke detector, type 4611, Wireless manual call point, type 4614 Addressable Base station for wireless units, type 4620, un Wireless local alarm acknowledge unit, type 4645, atbilst Direktīvas 2014/53/ES būtiskajām prasībām un citiem ar to saistītajiem noteikumiem.</p>
<p>LT Lietuvių [Lithuanian]</p>	<p>Šiuo PES SCBU/PFSEU deklaruoją, kad šis Wireless detector system; Wireless photoelectric smoke detector, type 4611, Wireless manual call point, type 4614, Addressable Base station for wireless units, type 4620, ir Wireless local alarm acknowledge unit, type 4645, atitinka esminius reikalavimus ir kitas 2014/53/ES Direktyvos nuostatas.</p>
<p>NL Nederlands [Dutch]</p>	<p>Hierbij verklaart PES SCBU/PFSEU dat het toestel Wireless detector system; Wireless photoelectric smoke detector, type 4611, Wireless manual call point, type 4614, Addressable Base station for wireless units, type 4620, en Wireless local alarm acknowledge unit, type 4645, in overeenstemming is met de essentiële eisen en de andere relevante bepalingen van richtlijn 2014/53/EU.</p>
<p>NO Norsk [Norwegian]</p>	<p>PES SCBU/PFSEU erklærer herved at utstyret Wireless detector system; Wireless photoelectric smoke detector, type 4611, Wireless manual call point, type 4614, Addressable Base station for wireless units, type 4620, og Wireless local alarm acknowledge unit, type 4645, er i samsvar med de grunnleggende krav og øvrige relevante krav i direktiv 2014/53/EU.</p>
<p>HU Magyar [Hungarian]</p>	<p>Alulírott, PES SCBU/PFSEU nyilatkozom, hogy a Wireless detector system; Wireless photoelectric smoke detector, type 4611, Wireless manual call point, type 4614, Addressable Base station for wireless units, type 4620, és Wireless local alarm acknowledge unit, type 4645, megfelel a vonatkozó alapvető követelményeknek és az 2014/53/EU irányelv egyéb előírásainak.</p>
<p>PL Polski [Polish]</p>	<p>Niniejszym PES SCBU/PFSEU oświadczam, że Wireless detector system; Wireless photoelectric smoke detector, type 4611, Wireless manual call point, type 4614, Addressable Base station for wireless units, type 4620, i Wireless local alarm acknowledge unit, type 4645, jest zgodny z zasadniczymi wymogami oraz pozostałymi stosownymi postanowieniami Dyrektywy 2014/53/UE.</p>
<p>PT Português [Portuguese]</p>	<p>PES SCBU/PFSEU declara que este Wireless detector system; Wireless photoelectric smoke detector, type 4611, Wireless manual call point, type 4614, Addressable Base station for wireless units, type 4620, e Wireless local alarm acknowledge unit, type 4645, está conforme com os requisitos essenciais e outras disposições da Directiva 2014/53/EU.</p>
<p>SI Slovensko [Slovenian]</p>	<p>PES SCBU/PFSEU izjavlja, da je ta Wireless detector system; Wireless photoelectric smoke detector, type 4611, Wireless manual call point, type 4614 Addressable Base station for wireless units, type 4620, in Wireless local alarm acknowledge unit, type 4645, v skladu z bistvenimi zahtevami in ostalimi relevantnimi določili direktive 2014/53/EU.</p>
<p>SK Slovensky [Slovak]</p>	<p>PES SCBU/PFSEU týmto vyhlasuje, že Wireless detector system; Wireless photoelectric smoke detector, type 4611, Wireless manual call point, type 4614, Addressable Base station for wireless units, type 4620, a Wireless local alarm acknowledge unit, type 4645, spĺňa základné požiadavky a všetky príslušné ustanovenia Smernice 2014/53/EÚ.</p>
<p>FI Suomi [Finnish]</p>	<p>PES SCBU/PFSEU vakuuttaa täten että Wireless detector system; Wireless photoelectric smoke detector, type 4611, Wireless manual call point, type 4614, Addressable Base station for wireless units, type 4620, ja Wireless local alarm acknowledge unit, type 4645, tyyppinen laite on direktiivin 2014/53/EU oleellisten vaatimusten ja sitä koskevien direktiivin muiden ehtojen mukainen.</p>

<p>SE Svenska [Swedish]</p>	<p>Härmed intygar PES SCBU/PFSEU att detta Wireless detector system; Wireless photoelectric smoke detector, type 4611, Wireless manual call point, type 4614, Addressable Base station för wireless units, type 4620, och Wireless local alarm acknowledge unit, type 4645, står i överensstämmelse med de väsentliga egenskapskrav och övriga relevanta bestämmelser som framgår av direktiv 2014/53/EU.</p>
<p>TR Türkçe [Turkish]</p>	<p>PES SCBU/PFSEU, işbu belgeyle şunu beyan eder: Wireless detector system; Wireless photoelectric smoke detector, type 4611, Wireless manual call point, type 4614, Addressable Base station için wireless units, type 4620, ve Wireless local alarm acknowledge unit, type 4645, 2014/53/EU Direktifinin temel gereksinimlerine ve diğer ilgili hükümlerine uygundur.</p>
<p>UA Ukrayins'ka [Ukrainian]</p>	<p>Цим PES SCBU/PFSEU заявляє, що це Wireless detector system; Wireless photoelectric smoke detector, type 4611, Wireless manual call point, type 4614, Addressable Base station для wireless units, type 4620, i Wireless local alarm acknowledge unit, type 4645, відповідає основним вимогам та іншим відповідним положенням Директиви 2014/53/ЄС.</p>

12. APPROVALS

Base Station 4620

Applicable directive/ Approval	Applicable standards	Notified body
CPR	EN54-17 EN54-18 EN54-25	VdS No. 0786-CPR-21393
VdS	EN54-17 EN54-18 EN54-25 VdS2344 VdS2504 VdS3448	VdS No. G214075
RED	EN60950-1 EN300 220-3-2 EN62479 EN301-489-1	Self declaration
RoHS	EN IEC 63000	Self declaration

Wireless Detector 4611

Applicable directive/ Approval	Applicable standards	Notified body
CPR	EN54-5 EN54-7	VdS No. 0786-CPR-21392
VdS	EN54-7 EN54-25 VdS2344 VdS2504 VdS3448	VdS No. G214074
RED	EN60950-1 EN300 220-3-2 EN62479 EN301-489-1	Self declaration
RoHS	EN IEC 63000	Self declaration

Wireless Manual Call Point 4614

Applicable directive/ Approval	Applicable standards	Notified body
CPR	EN54-5 EN54-7	VdS No. 0786-CPR-21613
VdS	EN54-11 EN54-25 VdS2344 VdS3448	VdS No. G219008
RED	EN62368-1 EN62749 EN300 220-3-2 EN301 489-1 EN301 489-3	Telefication
RoHS	EN IEC 63000	Self declaration



Wireless Local alarm acknowledge unit 4645

Applicable directive/ Approval	Applicable standards	Notified body
RED	EN62368-1 EN62749 EN300 220-3-2 EN301 489-1 EN301 489-3	Telefication
RoHS	EN IEC 63000	Self declaration

DOCUMENT NAME: TECHNICAL DESCRIPTION 4611, 4613, 4614, 4620, 4645
DOCUMENT NUMBER: MEW01764 EN
DATE OF ISSUE: 2014-10-31
REV: 11
DATE OF REVISION: 2023-09-26

Panasonic Fire & Security Europe AB

Jungmansgatan 12
SE-211 11 Malmö
SE
Tel: +46 (0)40 697 70 00