



5088 GATEWAY

Fire alarm solutions
technical description

Table of Contents

1.	INTRODUCTION	5
2.	ABBREVIATIONS	6
3.	GENERAL DESCRIPTION	7
3.1.	CABINET	9
3.2.	ETHERNET COMMUNICATION (10 BASE-T)	9
3.3.	PLC COMMUNICATION (RS232)	9
3.4.	MODEM COMMUNICATION (RS485/RS232)	9
3.5.	LED INDICATORS	9
4.	POWER SUPPLY	10
4.1.	EBL512 G3	10
4.1.1.	MAIN BOARD 5010	10
4.1.2.	MAIN BOARD 5012	10
4.2.	EBLONE	10
5.	OPERATING SYSTEM	10
5.1.	COMPATIBILITY	10
5.1.1.	UPDATE OPERATING SYSTEM	11
6.	SOFTWARE	12
6.1.	EBLWEB	12
7.	CONFIGURATION OF EBLWEB	13
7.1.	GATEWAY	13
7.1.1.	SETUP WIZARD	13
7.1.2.	GENERAL INFORMATION	16
7.1.3.	UNIT INFORMATION	16
7.1.4.	UNIT SETTINGS	16
7.1.5.	BROWSER SETTINGS	17
7.1.6.	GATEWAY/EBLNET SETTINGS	19
7.1.7.	NOTIFICATION SETTINGS	20
7.1.8.	SERVICE CONNECTION (ETH1)	24
7.1.9.	MACHINE CONFIGURATION	24
7.1.10.	CONVERT WEB-SERVER TO GATEWAY	25
8.	SOFTWARE AND CONFIGURATION	26
8.1.	EBLWEB SOFTWARE PACKAGE	26
8.1.1.	DOWNLOAD EBLWEB SOFTWARE	26
8.2.	EBLWEB CONFIGURATION DATA	26
8.2.1.	DOWNLOAD EBLWEB CONFIGURATION	27
8.2.2.	BACKUP (UPLOAD)	27
8.3.	SITE SPECIFIC DATA (SSD)	27
8.3.1.	DOWNLOAD VIA CONFIGURATION DATA	28
8.3.2.	DOWNLOAD VIA DOWNLOAD SSD FOR CIE	28

8.3.3.	DOWNLOAD VIA INDIVIDUAL MENU	28
9.	EBLWEB	29
9.1.	USER LOGIN	30
9.2.	USER LOGOUT	30
9.3.	SILENCE PC BUZZER (SOUND OFF)	31
9.4.	STATUS	31
9.4.1.	FIRE ALARM	33
9.4.2.	PRE-WARNING/CO-INCIDENCE/QUIET/DELAYED ALARM	33
9.4.3.	FAULT	33
9.4.4.	DISABLEMENTS	34
9.4.5.	TECHNICAL WARNING	35
9.4.6.	INTERLOCKING	35
9.4.7.	DOOR OPEN	35
9.4.8.	ZONES IN TEST MODE	35
9.4.9.	SERVICE SIGNAL	35
9.4.10.	COMMUNICATION ERROR	36
9.5.	EVENT LOG	37
9.5.1.	ALL LOG	37
9.5.2.	ALARM LOG	37
9.5.3.	INTERLOCKING LOG	37
9.5.4.	GENERAL LOG	37
9.5.5.	WEB LOG	37
9.5.6.	EXIT LIGHT LOG	37
9.5.7.	TEST MODE ALARM	37
9.6.	MAINTENANCE (WEB FUNCTION)	38
9.6.1.	WEB FUNCTION	38
9.6.2.	WEB LINK	39
9.7.	BASIC INFORMATION	39
9.7.1.	USERNAME / PASSWORD	39
9.7.2.	E-MAIL ADDRESS	40
9.8.	CONTROL UNIT	40
9.8.1.	CONTROL UNIT STATISTICS (SYSTEM INFORMATION)	41
9.8.2.	LOOP STATISTICS	41
9.9.	DETECTOR DIAGNOSTICS	41
9.9.1.	DETECTOR LIST	41
9.9.2.	SERVICE LIST	41
9.10.	DISABLEMENT OPERATIONS	42
9.10.1.	ZONE	42
9.10.2.	ZONE RANGE	42
9.10.3.	ZONE-ADDRESS	42
9.10.4.	OUTPUT	43
9.10.5.	OUTPUT TYPE	43
9.10.6.	ALARM DEVICES	44
9.10.7.	ROUTING EQUIPMENT	44

9.10.8.	ALERT ANNUNCIATION	44
9.10.9.	COM-LOOP / INPUT	44
9.11.	ACTIVATION OPERATIONS	45
9.11.1.	ZONE-ADDRESS	45
9.11.2.	OUTPUT	45
9.12.	TEST OPERATIONS	46
9.12.1.	ZONE TEST	46
9.12.2.	ZONE RANGE TEST	46
9.12.3.	ALARM DEVICES	46
9.13.	MAINTENANCE OPERATIONS	47
9.13.1.	SET CALENDAR TIME	47
9.13.2.	SYNCHRONIZE	47
9.13.3.	SILENCE ALARM DEVICES	47
9.13.4.	EVACUATE	47
9.13.5.	CALIBRATE OUTPUTS	47
9.13.6.	CLOSE FIRE DOOR	47
9.13.7.	FIRE DRILL MODE	47
10.	MOUNTING	48
11.	INSTALLATION AND WIRING	49
11.1.	EBL512 G3	49
11.1.1.	MAIN BOARD 5010	49
11.1.2.	MAIN BOARD 5012	50
11.2.	EBLONE	51
11.3.	CHECKLIST	51
12.	COMMISSIONING	52
13.	TECHNICAL DATA	53
14.	APPROVALS	54

1. INTRODUCTION

This document describes the Gateway, type number 5088.

The document contains information about the product and instructions on how to mount and connect it. It also describes the EBLWeb functions.

2. ABBREVIATIONS

CIE	Control and indicating equipment
S/W	Software
H/W	Hardware
NTP	Network Time Server
System	Two or more control units connected to a TLON / 5040 network
LAN	Local Area Network
SSD	Site Specific Data

3. GENERAL DESCRIPTION

The gateway is a hardware. The gateways function is depending on the software (EBLWeb) and on which configuration that is downloaded to the gateway.

It is intended for indoor use and in dry premises.

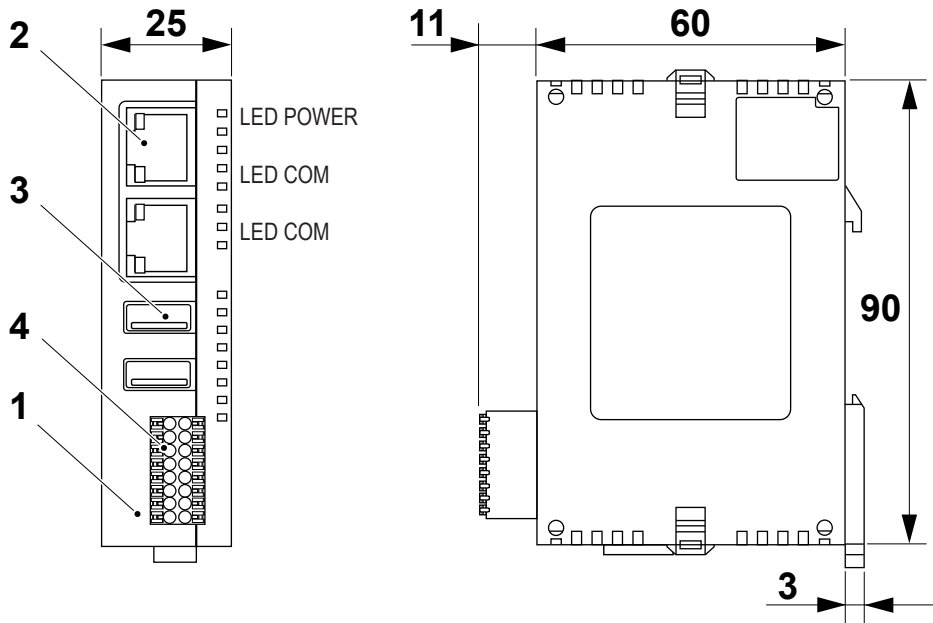

(Measure in mm)

- 1. Cabinet
- 2. Ethernet
- 3. USB
- 4. RS485/RS232

The software (EBLWeb) and configuration data are downloaded to the gateway via a commissioning tool, EBLWin. The EBLWin is depending on the EBL system and the EBL software version. EBLWeb is described in chapter 9. [EBLWEB on page 29.](#)

A Config tool (included in EBLWin) is used for configuration of the gateway. The configuration is downloaded to the gateway via TCP/IP. The gateway software is also downloaded via this tool.

The EBLWin version has to be the same as the EBLWeb software version regarding the two first digits, for example version 2.9.x.

Example of an EBL512 G3 system

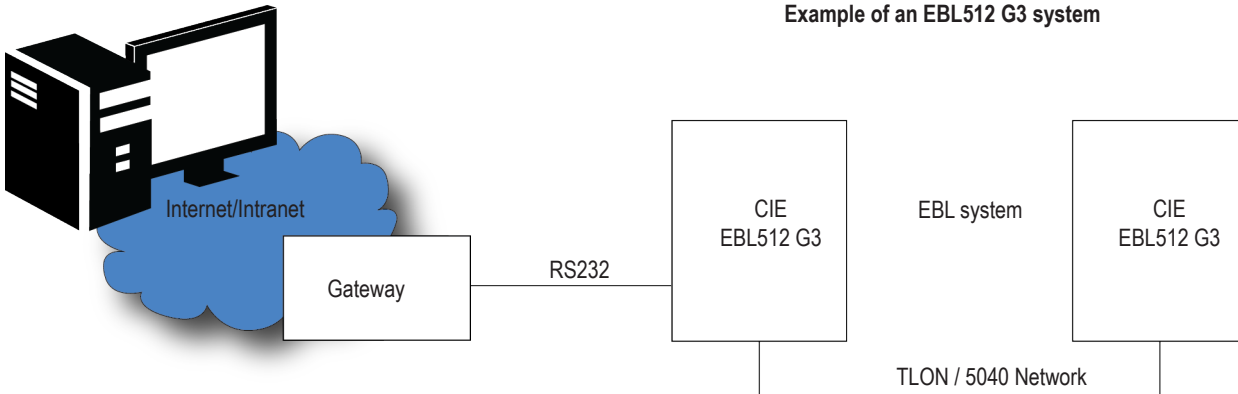

The gateway is used when one CIE or a system with two or more CIE in a TLON / 5040 Network shall be connected to Internet/ Intranet (LAN), to a Security Management System and/or as a Gateway. The unit can be used:

- For presentation of actual CIE status in a computer using the web browser. It can also send e-mail in case of pre-warning, fire alarm, fault, disablement, technical warning, and/or service signal.
- For remote control and two-way communication. Ten different users and three access levels.
- As a protocol interface to other computer systems. The following alternatives are available today:
 - EBLTalk (RS232 or TCP/IP) is an open protocol, used to transmit and present fire alarm information in a separate computer / system.
 - ESPA 4.4.4 (RS232) used to transmit and present fire alarm information in a paging system.
 - SIA (RS232) used to transmit and present fire alarm information in a separate computer application.
 - MODBUS (RS232 or TCP/IP) used to transmit and present fire alarm information in a separate computer application.
- As a protocol interface to a security management system via EBLNet (TCP/IP). EBLNet license is required.
- As an OPC UA server by using the OPC UA Gateway software, which runs simultaneously with EBLWeb 3.0.x (or later versions). EBLNet/OPC UA license is required. For more information, see Technical Description for OPC UA.

3.1. CABINET

The gateway consists of a black plastic cabinet, which shall be vertically mounted on the symmetric 35 mm DIN rail inside the CIE.

3.2. ETHERNET COMMUNICATION (10 BASE-T)

Two 10BaseT (RJ-45) connectors for a standard Ethernet cable (Ethernet cable is not supplied). This interface is used to connect the gateway to the Internet / intranet (LAN); Ethernet.

It is also used for EBL Talk via TCP/IP (EBL512 G3 only), and MODBUS V2 via TCP/IP.

3.3. PLC COMMUNICATION (RS232)

Non-insulated RS232 via screwless spring connection. Two RS232 cables are supplied. The cable shall be connected to the 16-pin connector COM1 (Send – Receive – Ground). This interface is used to connect the gateway to the CIE.

3.4. MODEM COMMUNICATION (RS485/RS232)

Insulated RS485/RS232 via screwless spring connection. The cable shall be connected to the 16-pin connector COM2. This interface is used to connect the gateway to a modem or a separate system (PC) when one of the protocols are used.

3.5. LED INDICATORS

There are three LED on the gateway:

- **POWER:** Indicating that the power supply is connected and is working.
- **TX1:** COM 1 indicating:
 - Data exchange (blinking)
- **TX2:** COM 2 indicating:
 - Data exchange (blinking)

4. POWER SUPPLY

24 V DC (Molex 3.5) connector. One power cables is supplied.

4.1. EBL512 G3

4.1.1. MAIN BOARD 5010

The 24V DC cable (1 m) has two plug-in connectors. One is for the gateway and the other cable connector has to be removed. The wires shall then be connected to the following screw terminals on the main board:

Brown to "J3:1" (+24 V DC),

Blue to "J3:2" (0 V) and

Green to "J2:3" (Earth)

4.1.2. MAIN BOARD 5012

Connect the plug-in connector to "J8" on the main board.

4.2. EBLONE

Connect the plug-in connector to "J12" on the main board.

5. OPERATING SYSTEM

Gateway 5088 is delivered with the new OS version 1.3. For EBL systems with version older than 3.6, the gateway OS may need to be downgraded to version 1.0.

It's possible to check in machine_config if the Gateway includes OS/BSP 1.3.662 (or later) as Main OS / Config OS.

The new operating system will have stricter rules for security, and it is implemented that the user must create a new password for admin and user accounts, see section [7.2. MACHINE CONFIGURATION](#) on page 13

5.1. COMPATIBILITY

The Gateways OS are compatible with EBLWeb according to table below.

EBLWeb version	BSP 1.0	BSP 1.3
V < 3.2.0	X	
V 3.2.0 - 3.5.X	X	X
V ≥ 3.6.0		X

5.2. UPDATE OPERATING SYSTEM

The new BSP/OS 1.3 will have stricter rules for security, so when the unit restarts after the update, you will be asked to create a new password for admin and user accounts. Remember the new password, there is no way to reset password or recover the Gateway.

The procedure below can also be used to downgrade Gateway OS with files v. 1.0.

Update Gateway 5088 with new BSP/OS

Do not turn off the power to the Gateway until the update is completed. The complete update will take around 10 minutes to install.

- Download the Gateway operating system files (BSP/OS) from Panasonic Fire and security homepage. Save locally.
- Unzip the BSP-zip to find 4 files (2 files for ConfigOS, 2 files for MainOS).
- Connect your PC to the Gateway 5088.
- Open your web browser and enter the URL `https://[IP address]/machine_config`.
Replace [IP address] with the IP address of your 5088 device.
- Go to "Management" to update Config OS and Main OS.
- Start with **ConfigOS**; Click on ConfigOS to expand it, and select "Update" in the ConfigOS box.

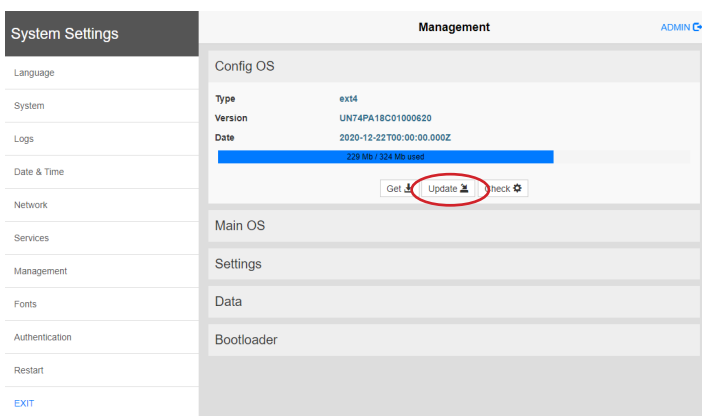

- Drag and drop the ConfigOS files into respective box for each file.
Image: un74-pa18-configos-1.3.859.rootfs.tar
MD5: un74-pa18-configos-1.3.859.rootfs.tar.gz.md5
- Follow the instructions on the screen, a success message will be shown when the update is completed.
- Do the same for **MainOS**. Drag and drop the MainOS files into respective box for each file.
Image: un74-pa18-mainos-1.3.859.rootfs.tar
MD5: un74-pa18-mainos-1.3.859.rootfs.tar.gz.md5
- After the update, go back to machine_config start page in the web browser, and you will be asked to set new passwords for both user and admin accounts if the passwords are considered insecure by the password rules of the new version.

**Remember your password! Write down the new password!
If you forget your password, you will not be able to use the Gateway anymore!**

6. SOFTWARE

The gateway can be used with the software EBLWeb (version ≥ 2.9).

6.1. EBLWEB

A gateway with the EBLWeb software is used when one CIE or an EBL512 G3 system with two or more CIE shall be connected to Internet / an intranet (LAN), to a Security Management system, and/or as a gateway as follows:

- For presentation of the actual CIE status in a PC (web browser).
- For remote control of the EBL system (via encrypted and safe two-way communication).
- As an e-mail client.
- EBLnet (via TCP/IP), for connection of an EBL system to a Security Management system.
- As a protocol interface.

7. CONFIGURATION OF EBLWEB

The EBLWeb is configured via EBLWin. The EBLWeb software, the configuration data and the site specific data (SSD) will be downloaded to the gateway via TCP/IP, See EBLWin menu Tools.

All the EBLWeb related menu options and dialog boxes in EBLWin are described in the following chapters.

7.1. GATEWAY

To configure a gateway for the EBL-system, a gateway must be added to a CIE (Control unit pop-up menu, Add gateway). Up to five gateways may be added to the EBL-system, with a limit of one gateway per CIE.

Once added, a properties dialog box for the gateway will be opened. More about each setting will be described below. The properties dialog box can always be accessed by right-clicking at a gateway in the EBLWin treeview, and select properties.

7.2. MACHINE CONFIGURATION

The FTP admin password and timezone can be changed for each gateway by right-clicking on respective gateway in the EBLWin treeview and select **Machine configuration**....

A webpage will be opened with different system settings for the gateway.

You may get an "Not secure" page warning.

FTP ADMIN

Select **Authentication**

Click on the **Edit** button to open a dialog to change the password for Admin.

Old password: Type the old username.

New password: Type the new password. (Only dots will be displayed.)

Confirm password: Re-type the new password once more. (Only dots will be displayed.)

The new password must contain:

- at least 8 characters
- contain at least:
 - one upper case letter
 - one lower case letter
 - one numerical character
 - one special character (symbol)

CURRENT TIMEZONE

When a new gateway is installed it is important to set the current timezone. Every day approximately one hour after midnight all calendars and clocks for the whole system will be synchronized according to gateway, when the NTP service is configured.

Select **Date & Time**

Click on the **Edit** button to open a dialog to change the current timezone.

EBLNET CERTIFICATE

As of version 3.6.0 of the EBLnet SDK, a certificate is required to be installed on the Gateway 5088. To ensure the security of our data, the certificate will enhance our communication with the support of encryption protocols, such as SSL/TLS.

The certificate comes installed by default on the Gateway so no action is required from your side unless you want to cross-sign the certificate.

CROSS SIGN CERTIFICATE

Cross-signing the CA certificate establishes a trusted relationship between the CA certificate and your organization's own CA certificate.

- a) Select **Authentication** and click "X.509 Certificate"

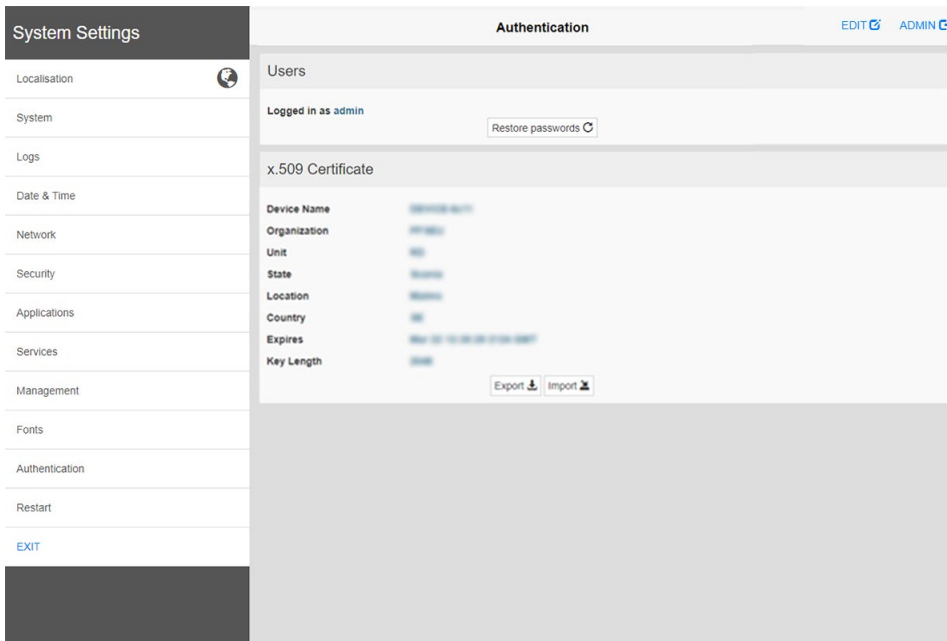

- b) Click **Export**. Select **Certificate Signed Request**.

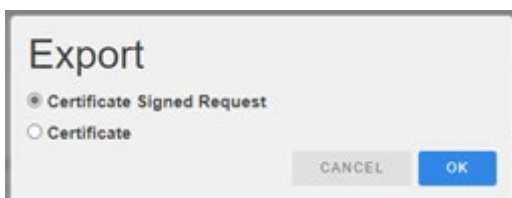

- c) Click **OK** and browse to where you want the certificate sign request saved.
 d) Have a Certificate Authority (administrator/IT department/...) process the request (a .csr file) and import the cross-signed certificate (a .crt file) back to the Gateway.

7.2.1. SETUP WIZARD

There is a wizard in EBLWin to guide you through the settings in the Gateway properties dialog box.

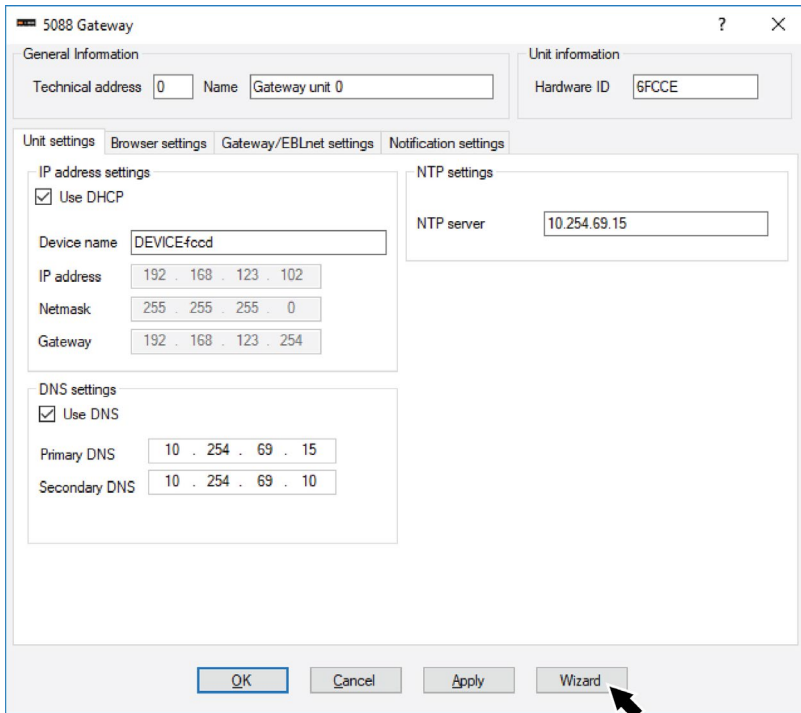

If a gateway is already added to the control unit, the wizard can also be started via the treeview.

- a) Right click on the Gateway in the treeview and select **Setup wizard**.

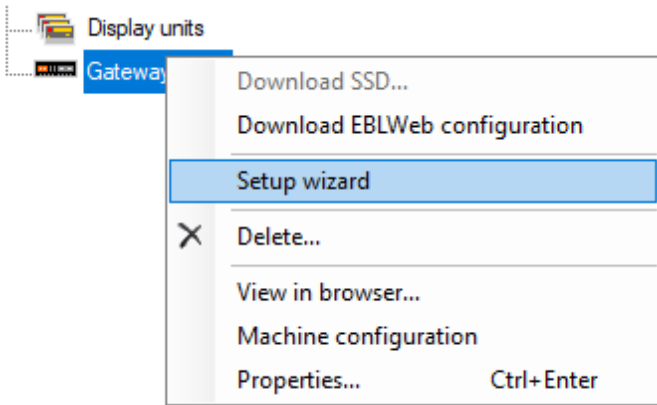

b) In the pop-up window, select the gateway in the list and click **Next**.

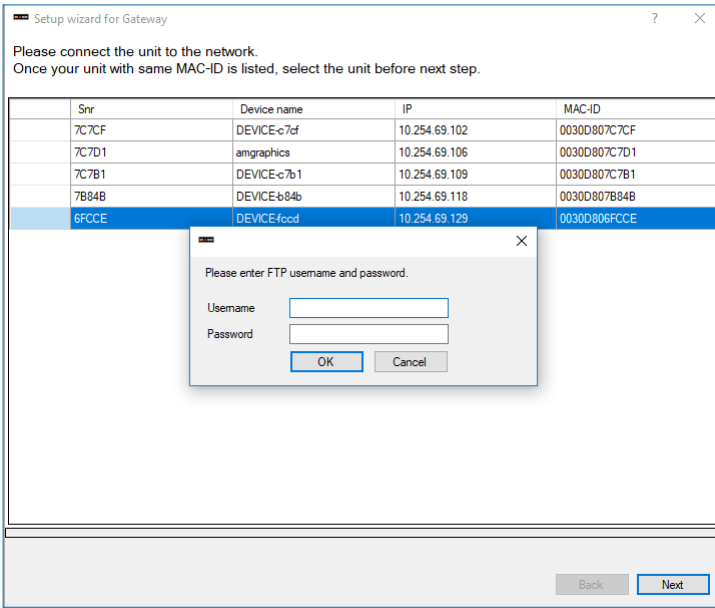

- c) Log on. The default username/password is **admin/admin**, but the password must be changed before running the **Setup wizard**, see section 7.2. MACHINE CONFIGURATION on page 13.
- d) Click **Next** and the wizard will guide you through the gateway configuration.
- e) In this step the wizard will retrieve the current setting from the gateway, change if necessary or click **Next**.

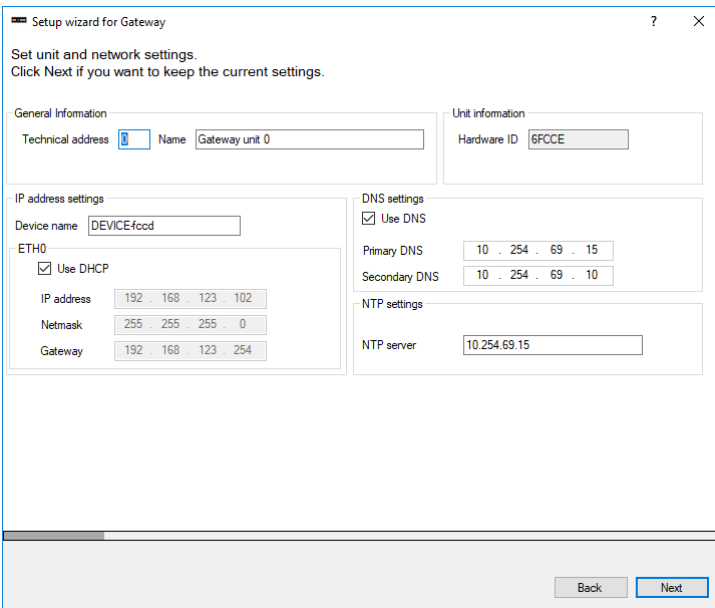

- f) In this step you can choose a program file to download together with the configuration.
If you don't want to download a file, click **Next** to finish the wizard.

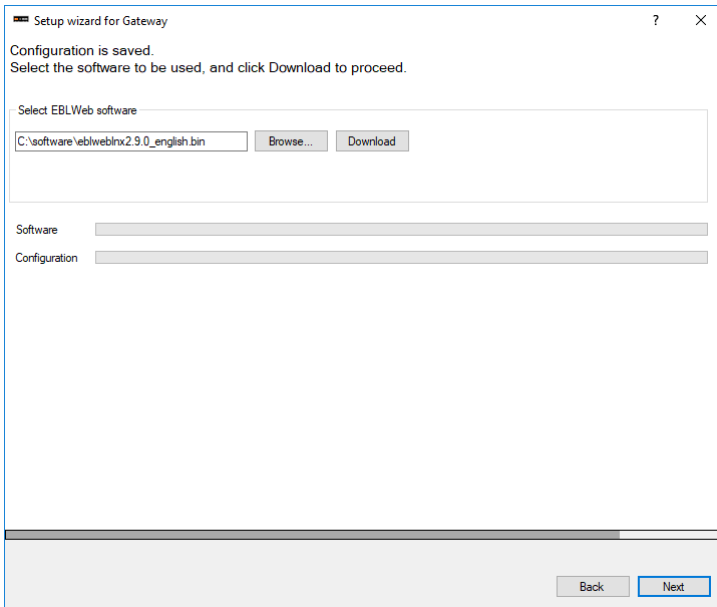

7.2.2. GENERAL INFORMATION

Since there is a limitation of the maximum numbers of gateways for an EBL system, each gateway must have a unique **technical address (0-4)**. A default gateway name is shown. The gateway **name** is shown in the treeview of EBLWin.

7.2.3. UNIT INFORMATION

To be able to download a specific configuration to a specific gateway, the **hardware ID** is required to identify the gateway unit. This ID can be found in the label on the backside of the gateway, ETH0:MAC-ID (last five characters).

7.2.4. UNIT SETTINGS

IP ADDRESS SETTING (ETH0)

Use DHCP: Select this option when a dynamic IP number shall be used (instead of a static, see below).

Device name: It is always recommended to have a device name, not only when a dynamic IP number is used.

If a static IP number shall be used the following data have to be specified:

- IP address
- Netmask
- Gateway

DNS SETTING

Use DNS: Select this option when Domain Name Server shall be used. DNS is used to translate hostnames into IP addresses.

Primary DNS: The IP address to the primary DNS

Secondary DNS: The IP address to the secondary DNS

NTP SETTINGS

Normally the CIE no. 00 in an EBL system will send out the date & time every day at midnight, to synchronize the clock in all CIE in the system as well as the clock in gateway.

For continuous correct time and synchronization of all the clocks an NTP server can be used. In this case, synchronization will be done one hour after midnight every day.

NTP server: The NTP server's IP address or server name

7.2.5. BROWSER SETTINGS

Settings in this tab page are related to how the web browser access and displays the web pages.

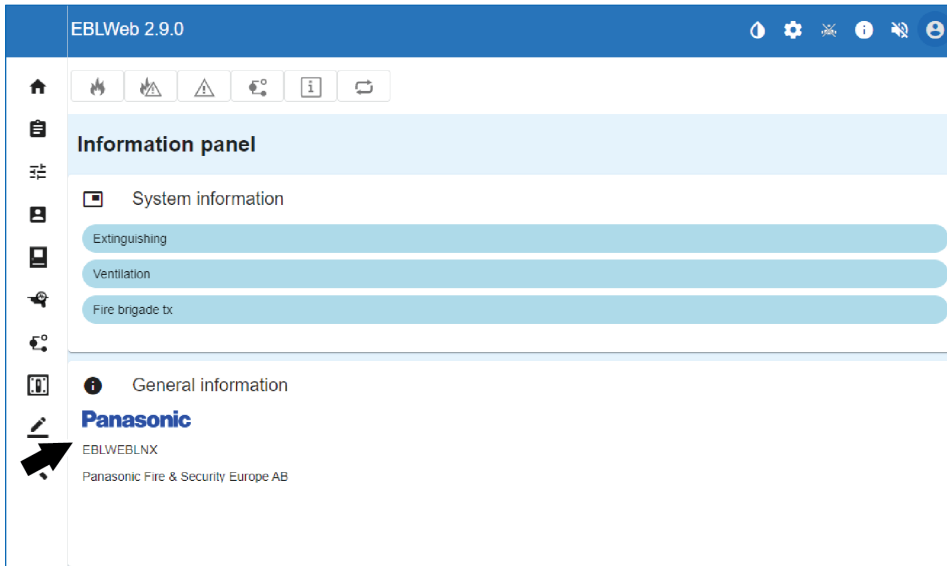

PROJECT NAME / CUSTOM TEXT

Project name and custom text are shown in the lower-left corner of Information Panel in General information.

Project name: a row of text that can be used to identify which EBL system this web server belongs to.

Custom text: Three rows of text for some additional information that can be shown, for example contact information.

CUSTOM LOGO

The custom logo will be shown in the lower-left corner in General information.

Browse: Opens a dialog to select an appropriate image (jpg, gif, bmp) used for logo. Recommended format size of image is 210 x 56 pixels.

If no **custom logo** is selected, the Panasonic logo will be used.

WEB LINK

If an alarm point is presented, it is possible to click the hyperlink for example a document or a camera to get more information about the alarm point. Up to 500 links can be used.

Web Links Settings

Level 1 (Web links for alarm points by default)

Zone	Address	Link 1	Link 2
000	00	http://www.panasonic.se	

Level 2 (Web links for alarm points by zone)

Zone	Address	Link 1	Link 2
*			

Level 3 (Web links for alarm points by zone-address)

Zone	Address	Link 1	Link 2
*			

Number of web links: 1/500

OK Cancel

The web links are based on three levels:

- **Level 1** is used to configure two links for all alarm points in the system. The links configured here will fully cover zone-addresses from 001-01 to 999-99.
- **Level 2** is used to configure two links for specific zones in the system. One zone per row. The links configured here will cover a full zone from ZZZ-01 to ZZZ-99, where ZZZ can be any zone from 001-999.
- **Level 3** is used to configure two links for specific alarm points in the system. One alarm point per row. The links configured here will cover one zone-address. 001-01 to 999-99 can be used.

BROWSER ACCESS

The web pages are by default configured to be accessed without encryption with **http**, but if more safety for access is needed, **https** access with encrypted communication via **SSL** can be used.

Browser URL: Type the web-address (URL) for accessing this gateway. This will be used as gateway URL in e-mails, if used.

- http://x
- https://x
- http/https://x

x = IP-address or the Device name.

SSL CERTIFICATE

If https is going to be used for webpage access, the SSL certificates needs to be defined.

The certificates can be configured to the EBLWeb with this option.

CA certificate: Type the path and file name (for example intermed.pem) or use the **Browse** button.

Private key: Type the path and file name (for example privkey.pem) or use the **Browse** button.

Server certificate: Type the path and file name (for example cert.pem) or use the **Browse** button.

7.2.6. GATEWAY/EBLNET SETTINGS

The EBLWeb is not only a web-server but can also be used as a protocol interface to another system.

The following protocol can be selected:

None: No protocol interface function will be used.

TATECO (ESPA 4.4.4): Used when fire alarm information shall be transmitted to and presented in a paging system.

EBLTalk: Used when fire alarm information shall be transmitted to and presented in a separate PC system, via RS232 or via TCP/IP. EBL Talk is an open protocol. For more information see "EBL Talk Protocol" Technical Description (MEW02060).

SIA: Used when fire alarm information shall be transmitted to and presented in a separate PC system, via the SIA protocol.

MODBUS: Used when fire information shall be transmitted via MODBUS protocol. Only occurrence of fire alarm per zone is registered.

MODBUS V2: Used when fire information shall be transmitted via MODBUS protocol via TCP/IP. Status information per alarm-point is registered.

COM PORT SETTINGS

COM port settings are used for the serial communication (RS232) setup used with EBLTalk or ESPA 4.4.4 protocols.

Normally **defaults** settings are used for EBLTalk or ESPA 4.4.4, but it's possible to change to suitable settings depending on corresponding client communication settings.

Click the **Reset defaults** button to restore the defaults settings for COM port.

EBLTALK SETTINGS

EBLTalk can be used via COM-port (RS232) or via Ethernet TCP/IP port.

SIA SETTINGS

Client IP (MAS) address and **Sender ID** are required. (Provided via the Local Area Network (LAN) administrator and/or SIA administrator.)

TATECO (ESPA 4.4.4) SETTINGS

ESPA 4.4.4 uses a COM-port and need a ESPA file to be defined. A ESPA file has to either be created (**Create**) or an existing file has to be selected (**Browse**).

MODBUS SETTINGS

MODBUS uses a COM-port and only 8 bits data with 1 stopbit is supported. A **slave ID** needs to be defined which is used by a Modbus software to retrieve data.

MODBUS V2 SETTINGS

MODBUS V2 uses default TCP/IP port 502. A slave ID needs to be defined which is used by a Modbus software to retrieve data.

EBLNET SETTINGS

EBLnet is used to connect the EBL system to a Security Management system.

EBLnet license 5097 is a kit containing:

- EBLnet license number document
- EBLnet license number label
- User instructions (MEW01479)

Use EBLnet: Has to be selected to activate the EBLnet function.

This has to be done before the gateway can be connected to the Security Management system.

An EBLnet key is also required. How to receive it and use it is described in the User instructions (MEW01986).

Port number: A port shall be set. Provided via the Local Area Network (LAN) administrator.

Port 80 is used for the web-interface and cannot be used here and if the Gateway protocol function "EBLTalk (TCP/IP)" is used, its port cannot be used here.

As of version 3.6.0 a certificate is required to be installed on the Gateway. For configuration of the EBLnet certificate, see [EBLNET CERTIFICATE](#) on page 14.

7.2.7. NOTIFICATION SETTINGS

The gateway can be configured to send e-mails if some type of events occur. Six different types of e-mails, based on the type of events, can be sent.

SMTP SERVER

IP address / Server name: Type in the **IP address** for a SMTP server or type in the **SMTP server name** if DNS is used.

Port number: Type in the port number for smtp server, the default port is 25.

Sender address: The address that will be shown as sender in e-mails sent from the gateway.

- Unchecked checkbox: default sender address "EBLWebMail" will be used.
- Checked checkbox: Write the wanted sender address.

The default sender address might not work for some SMTP servers that require a valid sender address.

SMTP AUTHENTICATION

Used if SMTP server requires authentication before sending e-mail.

Use SMTP authentication: Has to be selected to activate the authentication function.

Username: Username for the SMTP server.

Password: Password for SMTP server.

AUTHENTICATION TYPE

Type: Select authentication type, depending on SMTP server

SMTP Verify SSL: Requires certificate for verification.

- Unchecked checkbox: SSL verification with certificate not used
- Checked checkbox: Sender web browser certificate will be used or an existing certificate has to be selected (**Browse**) to verify against SMTP certificate

E-MAIL

Click on the **E-mail settings** button to open a dialog for configuration of each e-mail type. Up to five e-mail addresses can be configured for each type of e-mail and each e-mail address can be send as **To**, **CC**, or **BCC** address.

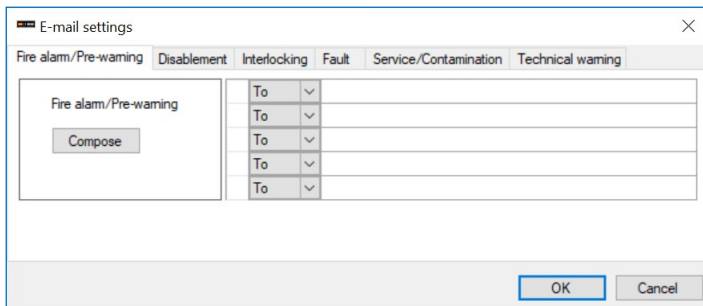

Click the **Compose** button for respective e-mail type to open a compose dialog box.

Subject: An e-mail "Subject" text shall be written, for example "Fire alarm". The "Subject" text will be shown in the receivers e-mail Inbox list view, together with the name of the e-mail sender, date and size.

Body: An e-mail "Body" text shall be written. Up to 500 characters can be used, including some parameters (see below). The parameters will in the receiver's e-mail be replaced with the information they represent.

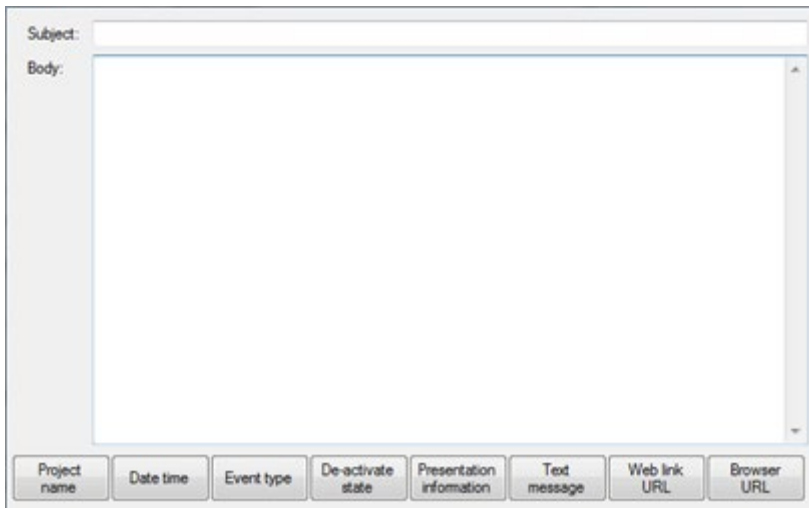

FIRE ALARM / PRE-WARNING E-MAIL

The following parameters can be used together with any other text in the **subject** and **body** text.

{Project name}: The custom name of the project which is configured in Browser settings, see section [7.2.5. BROWSER SETTINGS on page 19](#).

{Date time}: Date and time for occurrence of an event.

{Event type}: Type of alarm, i.e. pre-warning, heavy smoke etc.

{De-activate state}: Show if the alarm goes back to normal state for pre-prewarning, or the alarm point is reset.

{Presentation information}: The presentation number i.e. Zone-address.

{Text message}: The user definable **alarm text** showed in the fire alarm system CIE displays, for the alarm point respectively.

{Web link URL}: The links associated with an alarm-point, see section [7.2.5. BROWSER SETTINGS on page 19](#).

{Browser URL}: The URL to access the gateway.

DISABLEMENT E-MAIL

The following parameters can be used in the **subject** and **body** text.

{Project name}: The custom name of the project which is configured in Browser settings, see section [7.2.5. BROWSER SETTINGS on page 19](#).

{Date time}: Date and time for occurrence of an event.

{De-activate state}: Show if the disablement is re-enabled.

{Text message}: The **disablement text** shown in the fire alarm system CIE displays.

{Web link URL}: The links associated with an alarm-point. See section [WEB LINK on page 20](#).

{Browser URL}: The URL to access the gateway.

INTERLOCKING E-MAIL

{Project name}: The custom name of the project which is configured in Browser settings, see section [7.2.5. BROWSER SETTINGS on page 19](#).

{Date time}: Date and time for occurrence of an event.

{Event type}: Type of activation, i.e. INPUT, OUTPUT, or INPUT/OUTPUT activation.

{De-activate state}: De-activation of interlocking.

{Presentation information}: The presentation number i.e. Area-Point.

{Text message}: The user definable **interlocking text** shown in the fire alarm system CIE displays.

{Browser URL}: The URL to access the gateway.

FAULT E-MAIL

{Project name}: The custom name of the project which is configured in Browser settings, see section [7.2.5. BROWSER SETTINGS on page 19](#).

{Date time}: Date and time for occurrence of an event.

{De-activate state}: Show if fault is serviced.

{Presentation information}: The presentation number i.e. Technical number or/and Zone-address.

{Text message}: The **fault text** shown in the fire alarm system CIE displays, for the fault respectively.

{Web link URL}: The links associated with an alarm-point, see section [7.2.5. BROWSER SETTINGS on page 19](#).

{Browser URL}: The URL to access the gateway.

SERVICE / CONTAMINATION E-MAIL

{Project name}: The custom name of the project which is configured in Browser settings, see section [7.2.5. BROWSER SETTINGS on page 19.](#)

{Date time}: Date and time for occurrence an event.

{De-activate state}: Show if service signal is acknowledged.

{Presentation information}: The presentation number i.e. Zone-address.

{Web link URL}: The links associated with an alarm-point, see section [7.2.5. BROWSER SETTINGS on page 19.](#)

{Browser URL}: The URL to access the gateway.

TECHNICAL WARNING E-MAIL

{Project name}: The custom name of the project which is configured in Browser settings, see section [7.2.5. BROWSER SETTINGS on page 19.](#)

{Date time}: Date and time for occurrence of an event.

{De-activate state}: Show if technical warning is serviced.

{Text message}: The **technical warning text** shown in the fire alarm system CIE displays, for the technical warning respectively.

{Browser URL}: The URL to access the gateway.

7.2.8. SERVICE CONNECTION (ETH1)

If you do not have a DHCP server on your network you can still configure the Gateway locally. Connect the gateway to ETH1 and configure the gateway. Use a static IP number found on the gateway, ETH1 IP.

In the background, the address is set to ETH0 and when the gateway is connected to the DHCP server, it should be connected to ETH0.

7.2.9. CONVERT WEB-SERVER TO GATEWAY

If an old web-server will be replaced with a gateway you can convert the web-server in EBLWin to a gateway and keep the configuration from the web-server.

Right-click on the web-server in the EBLWin treeview and select **Convert to Gateway 5088**.

Change the **hardware ID** in the Unit settings tab. This ID can be found in the label on the backside of the gateway, ETH0:MAC-ID (last five characters).

8. SOFTWARE AND CONFIGURATION

The EBLWeb is mainly consisting of two parts that need to be downloaded into the gateway, to be fully functional.

- The software package (eblwebInx290_english.bin)
- The gateway configuration data and the EBL-system SSD.

8.1. EBLWEB SOFTWARE PACKAGE

The software package consists of all necessary files and configurations to make EBLWeb function as default, without any specific configuration. The specific language of preference is included in this package.

8.1.1. DOWNLOAD EBLWEB SOFTWARE

Click **Download EBLWeb software** in the **Tools** menu of EBLWin.

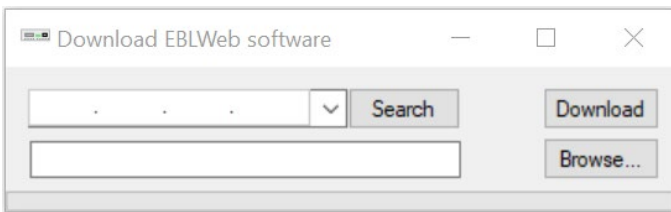

Click **Search** to look for all available gateways in the current network, and select the corresponding one for software download. Click **Browse...** to open the software package (EBLWeb290_english.bin) that should be downloaded.

Once the download is finished, a restart is required before the new software functions, but a pop-up dialog will remind the user wants to download configuration data before doing a restart.

8.2. EBLWEB CONFIGURATION DATA

The configuration data consists of the specific settings that are made via the gateway properties, see section [7.1. GATEWAY on page 12](#). The downloaded configuration data includes a backup of the configuration that can be retrieved via backup, see section [8.2.2. BACKUP \(UPLOAD\) on page 27](#).

8.2.1. DOWNLOAD EBLWEB CONFIGURATION

Click **Download EBLWeb configuration** in the **Tools** menu of EBLWin.

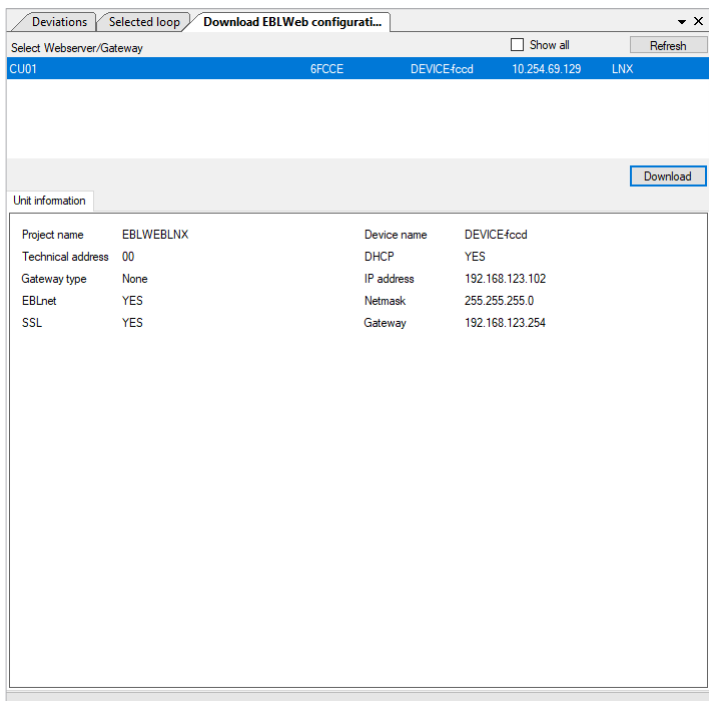

The gateway list in the top only shows all gateways that are configured with a valid hardware id, see [7.1. GATEWAY on page 12](#), and connected to the LAN. If the list does not show any gateways though a valid hardware id is configured, then network access to retrieve the gateways from the LAN might have been blocked by a firewall. Please permit EBLWin to access the network through firewall.

Select a gateway for download of configuration data.

Once the download is finished, a pop-up will remind the user that the gateway will automatically restart and needs to wait approximately 60 seconds before being accessible again.

8.2.2. BACKUP (UPLOAD)

Backup of configuration data can be done by clicking on the Backup EBLWeb configuration in the Tools menu.

The backup dialog is similar to the download dialog, see section [8.2.1. DOWNLOAD EBLWEB CONFIGURATION on page 27](#). It requires an added gateway in the tree view with valid hardware id, which would be shown in the gateway list. This is where there backup configuration will be stored once uploaded.

8.3. SITE SPECIFIC DATA (SSD)

Site specific data (SSD) is user configurable data from the EBLWin that is used in the EBL system including all control units. This data includes specific data such as, user data and alarm points in the system, etc.

This SSD needs to be downloaded into the gateway as well, since the EBLWeb needs the user data for its user handling system, and also for keeping track of how many control units the EBL system consists of.

The download of SSD data can be done in three ways.

- Via download of configuration data.
- Via download of SSD for control units.
- Via individually download for each gateway.

8.3.1. DOWNLOAD VIA CONFIGURATION DATA

This is done by checking **Include SSD Data** via the download of EBLWeb configuration dialog, see section [8.2.1. DOWNLOAD EBLWEB CONFIGURATION on page 27.](#)

8.3.2. DOWNLOAD VIA DOWNLOAD SSD FOR CIE

When downloading SSD for control units in EBLWin, there is a choice to **Download webserver SSD** in the dialog box. If this is selected, the SSD will be downloading for each connected gateway in each CIE.

EBLWin has to be logged on to the EBL system.

8.3.3. DOWNLOAD VIA INDIVIDUAL MENU

The SSD can be specifically downloaded to each gateway by right-clicking on respective gateway and select **Download SSD....**

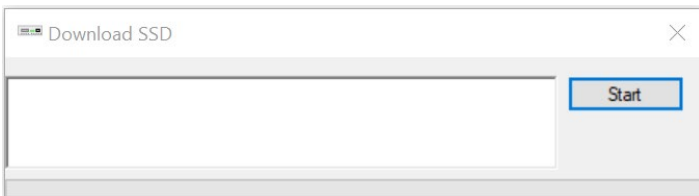

EBLWin has to be logged on to the EBL system.

9. EBLWEB

The following chapter describes all EBLWeb functions.

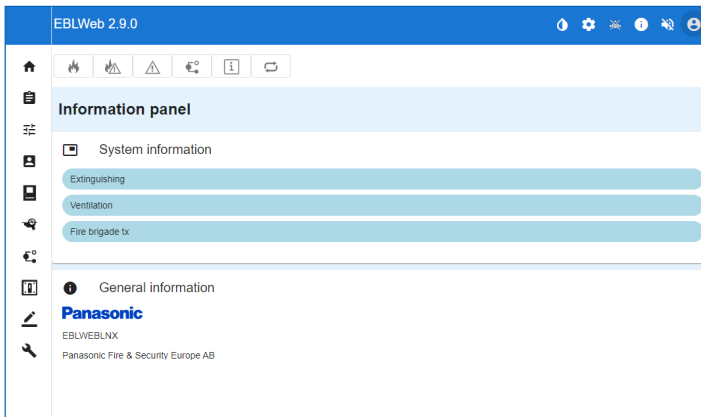

There is no support for anonymous login. A user with at least lowest priority level is required to be configured via EBLWin, even if the gateway is to be used for status information only.

User level 1 (Information only)

User level 2 (Building Officer)

User level 3 (Service Personnel)

For remote operations and access to corresponding information, a **username** and a **password** are always required for at least **user level 2** (Building Officer).

The EBLWeb has to be configured via the PC tool EBLWin, and it uses the same usernames and passwords as configured for the EBL-system.

It is also possible to configure a user with EBLWeb access only in EBLWin. In this case a stronger password can be defined. The password should consist of 6-10 characters and letters, digits and alphanumeric characters can be used. The letters are case sensitive.

9.1. USER LOGIN

Username: Type the Username for the user level

Password: Type the Password for the user level

Click **LOGIN** to open the status page.

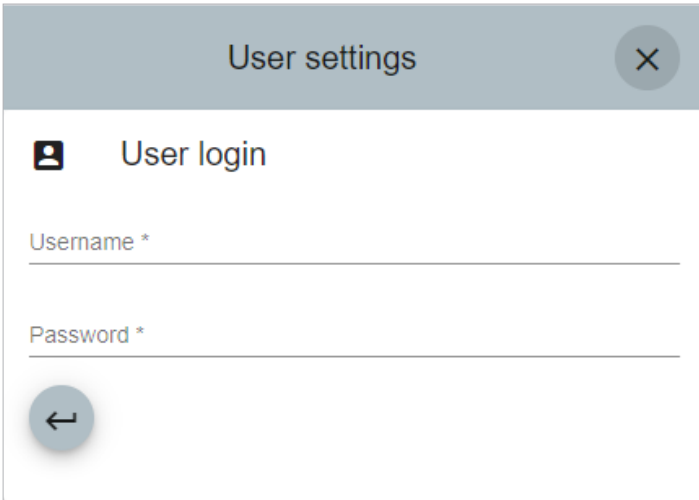

The screenshot shows a 'User settings' dialog box with a close button (X) in the top right corner. Inside the dialog, there is a 'User login' section with a user icon. Below the icon are two input fields: 'Username *' and 'Password *'. At the bottom left of the dialog is a circular button with a left-pointing arrow.

Operations are user dependant, which means that some menus or operations will be hidden from users with insufficient user level (which is depending on Username and Password).

The view is continuously updated approximately each 10th seconds.

In case of inconsistency between EBLWeb and CIE, synchronization can be done. After restart of the gateway, synchronization is done automatically.

9.2. USER LOGOUT

To logout the current session in EBLWeb, open the User information and click the logout button.



9.3. SILENCE PC BUZZER (SOUND OFF)

When a fire alarm is activated, the buzzer/speaker in the computer is used for sound alert.

Click the **Silence PC buzzer** button to silence the buzzer/speaker in the computer. The buzzer/speaker will be re-activated for a new alarm.



9.4. STATUS



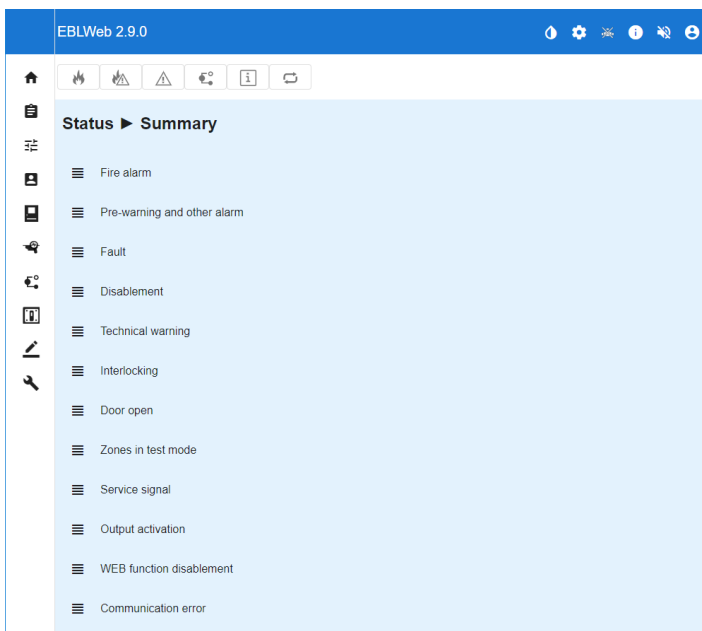



After login or in any other view, click the **Status** button to see the status summary view.



EBLWeb will present the current status of the EBL-system, showing current alarms, faults, disablements, and other deviations corresponding to the EBL CU. The status will be shown in different web-pages and also in the LED buttons on the top of the indication panel.

The LED-buttons will either blink or be constantly lit.

LED buttons explanation:



-  Fire alarm
-  Pre-warning/Co-incident/Quiet/Delayed alarm
-  Fault
-  Disablement
-  Technical warning
-  Interlocking

- N/A Door open

- N/A Zones in test mode

- N/A Service signal



- N/A Output activation

-  WEB function disablement
-  Communication error

The colour on the LED buttons is not visible until the event is activated.

Each of the different summary items in the list will be described in the following pages.

The list page for each status can be opened through either the list button  or corresponding LED button. Every list can show a certain amount of items per page, and to see the total amount of pages that the list contains of, and to navigate amongst the pages, there are page handling buttons.

Items per page 10 ▼ 0 of 0    

9.4.1. FIRE ALARM

In case of fire alarm, click on the **Fire alarm** LED button  or List button  to view the fire alarm list.

The **Time** (date and time), **Zone**, **Address** and **text** (alarm text) are displayed.

Type = Smoke, Heat, Multi, MCP, Exting.system or Other

State = Heavy smoke/heat, Test, Isolated and Alert Annunciation alarm acknowledge / not acknowledge.



Link1 = A hyperlink to open a web-camera, document, a drawing etc. for more information regarding the alarm point.

Link2 = A hyperlink to open a web-camera, document, a drawing etc. for more information regarding the alarm point.

Click the **Reset** button in the acknowledge column for acknowledgement of the current alarm. (Requires login on User level 2 or 3)

Click  to acknowledge all faults in the fault list.

9.4.2. PRE-WARNING/CO-INCIDENCE/QUIET/DELAYED ALARM

In case of pre-warning, co-incident alarm, quiet alarm, or delayed alarm, click on the pre-warning/co-incident alarm LED button  or List button  to view corresponding alarm list.

This list is separated into tab pages for respective pre-warning and alarm type.

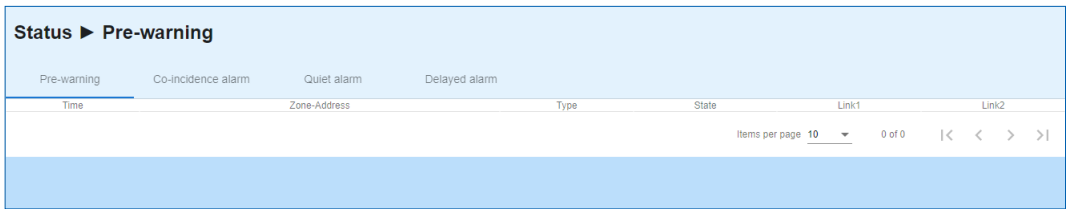

Status ▶ Pre-warning					
Pre-warning Co-incident alarm Quiet alarm Delayed alarm					
Time	Zone-Address	Type	State	Link1	Link2
Items per page 10 0 of 0 < < > >					

9.4.3. FAULT

In case of faults, click on the **Fault** LED button  or the List button  to view the fault list.

The **Time** (date & time), **Tech.No**, **Zone/address** (when applicable), **Fault description** (fault message) are displayed.

State (Serviced / Acknowledged / "Blank" = Neither Serviced nor Acknowledged).

Text = More info, such as alarm text if the fault is related to a detector etc. Place the pointer above the information icon.



Link1 = hyperlink to open a web-camera, document, a drawing etc. for more information regarding the alarm point.

Link2 = hyperlink to open a web-camera, document, a drawing etc. for more information regarding the alarm point.

Click the **Reset** button in the acknowledge column for acknowledgement of the current fault (Requires login on User level 2 or 3).

Click  to acknowledge all faults in the fault list.

9.4.4. DISABLEMENTS

In case of disablements, click on the **Disablement** LED button  or List button  to view the corresponding disablement list. The list is separated into tab pages for respective disablement type.

Status ► Disablement ► Zone or Zone-Address							
Zone or Zone-Address	Output	Output type	Interlocking	COM-loop/input	Other		
Time	Zone-Address	Re.Time	Reason	Info	Link1	Link2	Re-enable
Items per page 10 0 of 0 < < > >							

Click the **Reset** button for re-enabling the disablement (Requires login on User level 2 or 3).

ZONE OR ZONE-ADDRESS DISABLEMENT

The **Time** (date & time), **Zone-Address**, **Re-enable time**, **Reason**, and **Info** (e.g. via the menu) is displayed.

Link1 = A hyperlink to open a web-camera, document, a drawing etc. for more information regarding the alarm point.

Link2 = A hyperlink to open a web-camera, document, a drawing etc. for more information regarding the alarm point.

OUTPUT DISABLEMENT

The **Time** (date & time), **Control unit**, **Exp.Board**, **Loop**, and **Address** are displayed.

Output type = The type of output, such as, Control, Ventilation, Extinguisher, Alarm devices, ATR, Neutral, or FTR.

Output = The output number.

Reason = e.g. via the menu.

OUTPUT TYPE DISABLEMENT

The **Time** (date & time), and **Control unit** is displayed.

Output type = The type of output, such as, Control, Ventilation, Extinguisher, Alarm devices, ATR, Neutral, or FTR.

Reason = e.g. via the menu.

INTERLOCKING (OUTPUT) DISABLEMENT

The **Time** (date & time), and **Area-Point** and are displayed.

COM-LOOP/INPUT DISABLEMENT



The **Time** (date & time), **Control unit**, Exp.Board, Tech.No., Loop, and Sub-loop (Input) is displayed.

OTHER (ALERT ANNUNCIATION) DISABLEMENT

The **Time** (date & time) and **Text** (disablement text) are displayed.

This list is only showing Alert annunciation disablement.

9.4.5. TECHNICAL WARNING

In case of technical warning, click on the **Technical warning** LED button  or the **List** button  to view the Technical warning list.

The **Time** (date & time), **Text** (technical warning text), and **State** (Serviced / "Blank" = Not Serviced) are displayed.

Click  to reset all technical warnings in the list.

9.4.6. INTERLOCKING

In case of interlocking input/output activations, click on the **Interlocking** LED button  or the **List** button  to view the interlocking list.

The **Time** (date and time), **Area-Point** and **Text** (interlocking text) are displayed.

Input = Input is activated.

In.Act.Time = The input activation time.

Output = Output is activated.

Out.Act.Time = The Output activation time.

Click the **Reset** button for reset of activated interlocking output (Requires login on User level 2 or 3).

9.4.7. DOOR OPEN

In case of open doors, click the **List** button  to view the door list.

The **Time** (date & time) and **Control unit** are displayed.

FBP = The number of the Fire Brigade Panel, in case of door opened at FBP.

9.4.8. ZONES IN TEST MODE

In case of zones in test mode, click the **List** button  to view the list of zones in test mode.

The **Time** (date & time) and Zone are displayed.

Click the **De-activate** button for de-activation of the zone in test (Requires login on User level 2 or 3).

9.4.9. SERVICE SIGNAL

In case of detectors having activated service signal, click the **List** button  to view the service signal list.

The **Time** (date and time), Zone-Address, Tech.No, and Outdated (alarm text) are displayed.

Link1 = A hyperlink to open a web-camera, document, a drawing etc. for more information regarding the alarm point.

Link2 = A hyperlink to open a web-camera, document, a drawing etc. for more information regarding the alarm point.

Click the **Acknowledge** button for acknowledgement of service signal (Requires login on User level 3).

OUTPUT ACTIVATION

In case of forced output activations, click the **List** button  to view the output activation list.

The **Time** (date & time), **Control unit**, **Exp.Board**, **Loop**, and **Address** are displayed.

Output = The output number.

Click the **De-activate** button for de-activation of the force activated output (Requires login on User level 2 or 3).

WEB FUNCTION DISABLEMENT (WEB STATUS)

In case of any WEB-function disablement, click the **WEB function** LED button  or the **List** button  to view the WEB function disablement list.

This view shows the current status of disablement of WEB functions, such as E-mails, PC-buzzer, and Gateway. It also shows the time-stamp for previous login and current EBLWeb software version.

9.4.10. COMMUNICATION ERROR

In case of any communication error, click on the **Communication error** LED button  or the **List** button  to view the communication error list.

This view shows the current communication state for several kinds of communication errors as listed. If in error state, the state will be 'blinking' **Error**, otherwise a steady **Normal** will be shown.

EBL - WEB	Communication between CU and EBLWeb.	Could be a problem with the serial cable between the gateway and the CU or incompatible SW versions (e.g. CU is running version 2.6.x and gateway is running version 2.9.x).
WEB - Browser	Communication between gateway and browser	Normally no TCP/IP connection with gateway from browser.
E-mail SMTP - WEB	Communication between SMTP-server and EBLWeb	Normally no access to SMTP server. No e-mail can be sent.
WEB - Gateway	Communication between EBLWeb and current configured gateway protocol interface.	Normally no replies/ACK from the gateway device.

9.5. EVENT LOG

Click the **Event log** button to show the Event log view.



The event log of EBLWeb consists of different types of logs, where three of them are the same as in the control unit, namely, Alarm log, Interlocking log and General log. All logs in EBLWeb are circular logs. The events in an EBL-system are stored in the CIE and in the gateway.

If the gateway is disconnected, the events during that time will not be saved in the gateway, not shown in the event log. When you restart the gateway, the event log will be erased.

All the logs can be saved as PDF.

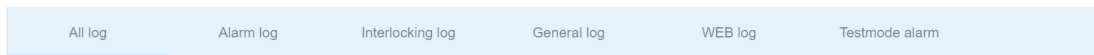

The **Time** (date & time), and **Event** (event text) is displayed.

Description = Additional information of the event when applicable.

User = The user that performed that specific event.

Origin = The source where the event originated from.

9.5.1. ALL LOG

The all log is a special log in EBLWeb that collect all events in the same log with a capacity of 9999 log events.

9.5.2. ALARM LOG

This log contains all alarm related events. This log shall show the same events as the CU alarm log with a capacity of 999 log events.

9.5.3. INTERLOCKING LOG

This log contains all interlocking related events. This log shall show the same events as the CU interlocking log with a capacity of 999 log events.

9.5.4. GENERAL LOG

This log contains all general events. This log shall show the same events as the CU general log with a capacity of 999 log events.

9.5.5. WEB LOG

This log contains all web related events, with a capacity of 999 log events.

9.5.6. EXIT LIGHT LOG

This is a log to keep track of the monthly and annual tests. This exit light log is used to record the exit light tests in a list, with a capacity of 999 log events.

9.5.7. TEST MODE ALARM

This is a log to keep track of the test mode alarms. The test mode alarms normally go back to normal after 10 seconds. This test mode alarm log is used to record the test mode alarms in a list.

9.6. MAINTENANCE (WEB FUNCTION)

Click the **Maintenance** button to show the Maintenance view.



This view contains two tab pages, one for WEB functions and the other for Web links.

9.6.1. WEB FUNCTION

The tab page shows WEB function disablement page with operations to enable or disable the WEB function. Each function is **Enabled** or **Disabled** by a clicking the corresponding switch button.

ALL E-MAIL FUNCTION

This disablement is to stop all kinds of e-mail sending from EBLWeb.

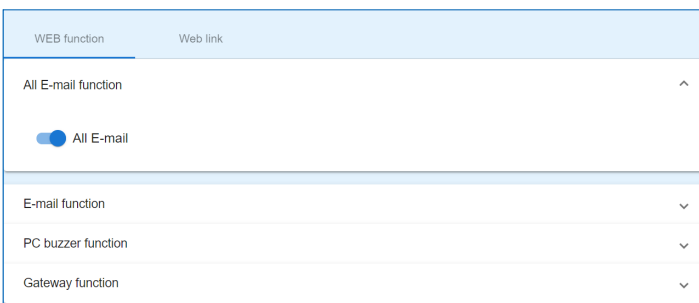

E-MAIL FUNCTION

This disablement is related to each type of e-mail, **Fire alarm/Pre-warning**, **Disablement**, **Interlocking**, **Fault**, **Service**, and **Technical warning**.

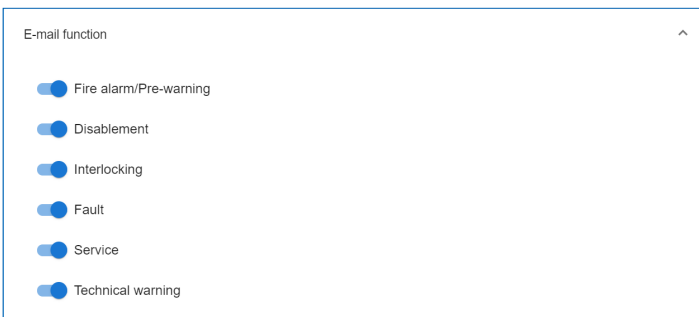

PC BUZZER FUNCTION

This disablement is related to the PC-buzzer, which sounds for each new fire alarm or control unit communication fault. There is also a button for test of the PC-buzzer (four long beeps).

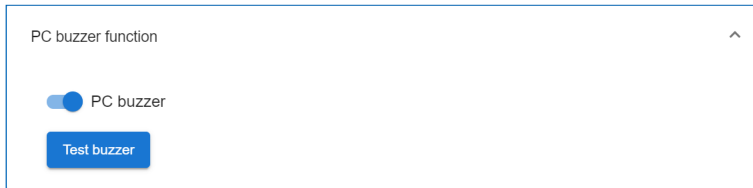

GATEWAY FUNCTION

This disablement will stop the gateway to send messages to the current configured gateway, such as ESPA 4.4.4, EBLTalk, or SIA.

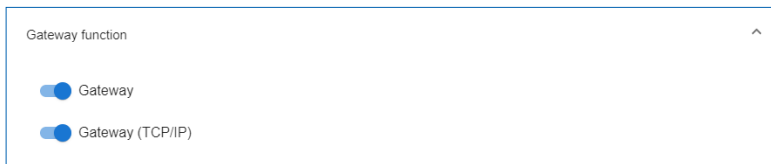

9.6.2. WEB LINK

Web links are URLs used for additional documents or web-cameras for a defined zone-address/detector. This tab page will show a list of all web links currently configured via EBLWin.

Maintenance ► Web link			
WEB function		Web link	
Zone	Address	Link1	Link2
000	00		

Items per page 10 1 - 1 of 1 |< < > >|

9.7. BASIC INFORMATION

Click the **Basic information** button to show the basic information view.



This view has a tab page that shows the user information for currently logged in user and another tab page for the e-mail address configuration for each e-mail type.

9.7.1. USERNAME / PASSWORD

In this view, the current user may change the user login password. The password change requires to input both current password and the new password. Once applying the password change, the new password will be changed for the EBL-system as well.

9.7.2. E-MAIL ADDRESS

The e-mail handling in EBLWeb handles six different types of e-mails. Each e-mail type can be disabled, see section 9.6.1. WEB FUNCTION on page 38. The EBLWin configured e-mail addresses for recipients are shown in this tab page. Each e-mail address shown has a button to send a test mail to the configured e-mail address.

Basic information ► E-mail address	
User information	E-mail address
Fire alarm/Pre-warning	▼
Disablement	▼
Interlocking	▼
Fault	▼
Service	▼
Technical warning	▼

9.8. CONTROL UNIT

Click the **Control unit** button to access the control unit list view.



This page show all the control units in the EBL-system. Which control unit that should be monitored and be included in synchronization is determined by the SSD. Those control units that are included according to SSD.

Each control unit row has icons for control unit, main loop, and SUB-loops. Click each icon for statistics data.



Control unit



Main loop



SUB-loop

Each control unit row has an icon for synchronization status.



Synchronization is in progress



Synchronization not started



Synchronization is finished

9.8.1. CONTROL UNIT STATISTICS (SYSTEM INFORMATION)

This page shows the system information of selected CU and consists of momentary statistics data asked from the connected CU. The **current consumption for rectifier**, **current consumption for charger**, **battery temperature**, **low capacity voltage difference**, **site name** (also time of SSD download), and **software version** for the CU is displayed.

9.8.2. LOOP STATISTICS

This page shows the COM loop statistics for communication in selected CU.

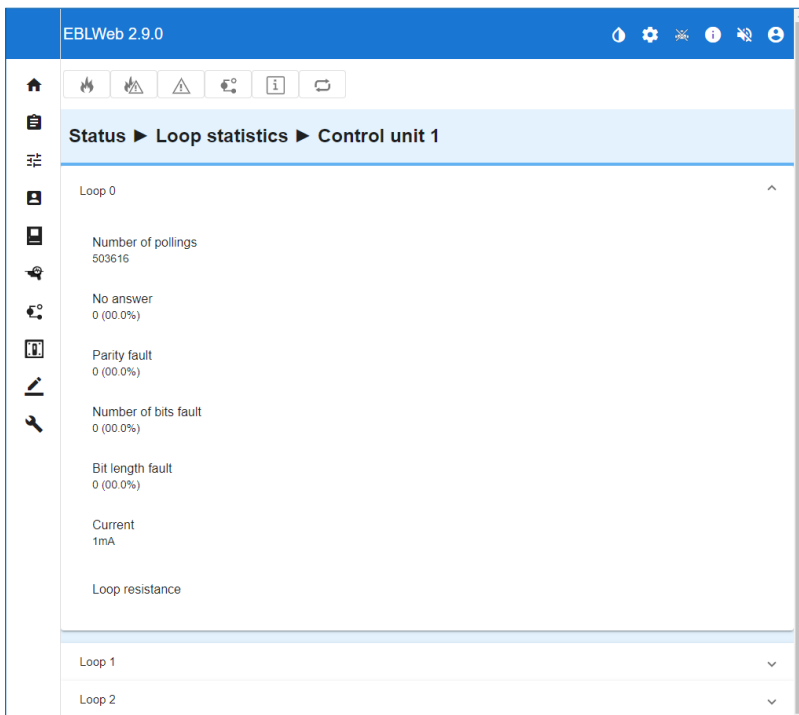

9.9. DETECTOR DIAGNOSTICS

Click the **Detector diagnostics** button to access the detector diagnostic page.



This page shows two kinds of lists regarding detector information.

9.9.1. DETECTOR LIST

This page asks the control unit for sensor values. Specify from which technical number the sensor list shall start asking the control units.

9.9.2. SERVICE LIST

This page will list all detectors that have activated service signal, see section [9.4.9. SERVICE SIGNAL](#) on page 35.

9.10. DISABLEMENT OPERATIONS

Click the **Disablement operations** button to access a list of different disablement operations.



Click on each item to see the corresponding disablement operations.

Operations ► Disablement	
Zone	▼
Zone range	▼
Zone-Address	▼
Output	▼
Output type	▼
Alarm devices	▼
Routing equipment	▼
Alert annunciation	▼
COM-loop/input	▼

9.10.1. ZONE

A specified Zone can be disabled / re-enabled and an automatic re-enable time can be set.

Operations ► Disablement	
Zone	^
Zone *	▼
003	
HH	▼
01	
MM	▼
20	
<input type="button" value="Disable"/> <input type="button" value="Re-enable"/>	

9.10.2. ZONE RANGE

A specified zone range (from zone - to zone) can be disabled / re-enabled and an automatic re-enable time can be set.

9.10.3. ZONE-ADDRESS

A specified alarm point (Zone-Address) can be disabled / re-enabled and an automatic re-enable time can be set.

9.10.4. OUTPUT

A sub menu for several types of outputs:

Operations ► Disablement	
Zone	▼
Zone range	▼
Zone-Address	▼
Output	▲
Loop unit output	▼
Voltage output (S)	▼
Relay output (R)	▼
Expansion board output	▼
Interlocking output	▼

LOOP OUTPUT UNIT

A specified loop unit (**tech.no.**), **output** (0-3) can be disabled / re-enabled.

VOLTAGE OUTPUT (S)

A specified voltage **output** (0-3) in a specified **CIE** can be disabled / re-enabled.

RELAY OUTPUT (R)

A specified relay **output** (0-1) in a specified **CIE** can be disabled / re-enabled.

EXPANSION BOARD OUTPUT (VALID FOR EBL512 G3)

4583 has three outputs (0-2).

A specified **output** (0-7) on a specified 4581/4583 expansion **board** (0-5), in a specified **CIE**, can be disabled / re-enabled.

INTERLOCKING OUTPUT

An interlocking can be disabled / re-enabled via a specified interlocking combination **Area-Point**.

9.10.5. OUTPUT TYPE

A sub menu for several types of outputs. All outputs of the type respectively will be collectively disabled/re-enabled.

CONTROL OUTPUT

All outputs of type "control" can be collectively disabled / re-enabled (all at the same time) in **all CIE (**)** or in a specified **CIE**.

VENTILATION OUTPUT

All outputs of type "ventilation" can be collectively disabled / re-enabled (all at the same time) in **all CIE (**)** or in a specified **CIE**.

EXTINGUISHING OUTPUT

All outputs of type "extinguishing" can be collectively disabled / re-enabled (all at the same time) in **all CIE (**)** or in a specified **CIE**.

INTERLOCKING OUTPUT

All outputs of type "interlocking" can be collectively disabled / re-enabled (all at the same time) in **all CIE (**)** or in a specified **CIE**.

9.10.6. ALARM DEVICES

All outputs of type "alarm devices" can be collectively disabled / re-enabled (all at the same time) in **all CIE**.

9.10.7. ROUTING EQUIPMENT

A submenu with Fire routing equipment and Fault routing equipment.

FIRE ROUTING EQUIPMENT

The **FIRE** output for routing equipment (fire brigade tx) can be disabled / re-enabled.

FAULT ROUTING EQUIPMENT

The **FAULT** output for routing equipment (fault tx) can be disabled / re-enabled.

9.10.8. ALERT ANNUNCIATION

The Alert Annunciation function can be disabled / re-enabled.

This operation has higher priority than any time channel controlling this function.

9.10.9. COM-LOOP / INPUT

A sub menu with the three types that can be disabled.

COM-LOOP

A specified COM **Loop** (0-3) or **SUB-loop** (0-3) in a specified **CIE** can be disabled / re-enabled.

ZONE-LINE INPUT (VALID FOR EBL512 G3)

A specified zone line **input** (0-7) on a specified 8 zones expansion **Board** (0-5), in a specified **CIE**, can be disabled / re-enabled.

ZONE INTERFACE

The zone line input (0) on a specified COM loop unit (**Address**) on a specified COM **Loop** (0-3) in a specified **CIE**, can be disabled / re-enabled.

9.11. ACTIVATION OPERATIONS

Click the Activation operations button to access a list of different activation operations.



Click on each item to see the corresponding activation operations.

Operations ► Activation	
Zone-Address	▼
Output	▼

9.11.1. ZONE-ADDRESS

A specified alarm point (**Zone-Address**) can be activated, i.e. set in fire alarm mode.

Reset the fire alarm with the **de-activate** button or in the fire alarm list, like any other fire alarm, see section [9.4.1. FIRE ALARM on page 33](#).

9.11.2. OUTPUT

A sub menu for several types of outputs.

LOOP UNIT OUTPUT

A specified loop unit (**Tech. No.**), **Output** (0-2) can be activated / de-activated.

VOLTAGE OUTPUT (S)

A specified voltage **Output** in a specified **CIE** can be activated / de-activated.

RELAY OUTPUT (R)

A specified relay **Output** (0-1) in a specified **CIE** can be activated / de-activated.

EXPANSION BOARD OUTPUT (VALID FOR EBL512 G3)

A specified **output** (0-7) on a specified 4581/4583 expansion **board** (0-5), in a specified **CIE**, can be activated / de-activated.

4583 has three outputs (0-2).

INTERLOCKING OUTPUT

An interlocking output can be activated / de-activated via a specified interlocking combination **Area-Point**.

9.12. TEST OPERATIONS

Click the **Test operations** button to access a list of different test operations.



Click on each item to see the corresponding test operations.

Operations ► Test	
Zone test	▼
Zone range test	▼
Alarm devices	▼

9.12.1. ZONE TEST

A specified **zone** can be set in test mode, i.e. test mode activated / de-activated.

Zones in test mode can also be de-activated from the Zones in test mode list, see section

[9.4.8. ZONES IN TEST MODE on page 35.](#)

9.12.2. ZONE RANGE TEST

A specified **zone range** (from zone - to zone, up to 100 zones) can be set in test mode, i.e. test mode activated / de-activated.

Zones in test mode can also be de-activated from the Zones in test mode list, see section

[9.4.8. ZONES IN TEST MODE on page 35.](#)

9.12.3. ALARM DEVICES

All outputs of type "alarm device" can be collectively activated / de-activated for test. All outputs can be activated / de-activated at the same time in **all CIE (**)** or in a specified **CIE**.

9.13. MAINTENANCE OPERATIONS

Click the **Maintenance operations** button to access a list of different maintenance operations.



Click on each item to see the corresponding maintenance operations.

Operations ► Maintenance	
Set calendar and time	▼
Synchronize	▼
Silence alarm devices	▼
Evacuate	▼
Sensitive fault detection mode	▼
Calibrate outputs	▼
Close fire doors	▼
Fire drill mode	▼

9.13.1. SET CALENDAR TIME

The date and time can be set for the gateway and the EBL system. Click **Get** to choose the current date and time from the computer or set the date and time manually. Click **Set** to send the date and time to the gateway.

9.13.2. SYNCHRONIZE

This operation starts a synchronization of the EBL-system, which includes CIE, EBLWin, and EBLWeb. The synchronization status of each CIE is shown in the CIE list, see section [9.8. CONTROL UNIT on page 40](#).

9.13.3. SILENCE ALARM DEVICES

This operation works like the **silence alarm devices** button on the CIE front.

Silence alarm devices cannot be activated if there is no fire alarm in the system.

9.13.4. EVACUATE

This operation activates / de-activates the evacuate function.

9.13.5. CALIBRATE OUTPUTS

This operation activates / de-activates the EBL-system for sensitive fault detection mode.

9.13.6. CLOSE FIRE DOOR

This operation will collectively close all fire doors, that is programmable outputs with a control expression containing one or more trigger conditions Fire Door Closing (zone – address), in **all CIE (**)** or in a specified **CIE**.

9.13.7. FIRE DRILL MODE

Fire drill mode activated will disable all outputs except outputs of type Control neutral and type Alarm devices.

An alarm point activating fire alarm will now activate all alarm devices, in order to evacuate the building (a fire drill).

10. MOUNTING

Gateway shall be vertically mounted on the symmetric 35 mm DIN rail inside the CIE.
Cable and accessories kit is supplied with the gateway.

11. INSTALLATION AND WIRING

Screen wire termination is not provided.

11.1.EBL512 G3

11.1.1. MAIN BOARD 5010

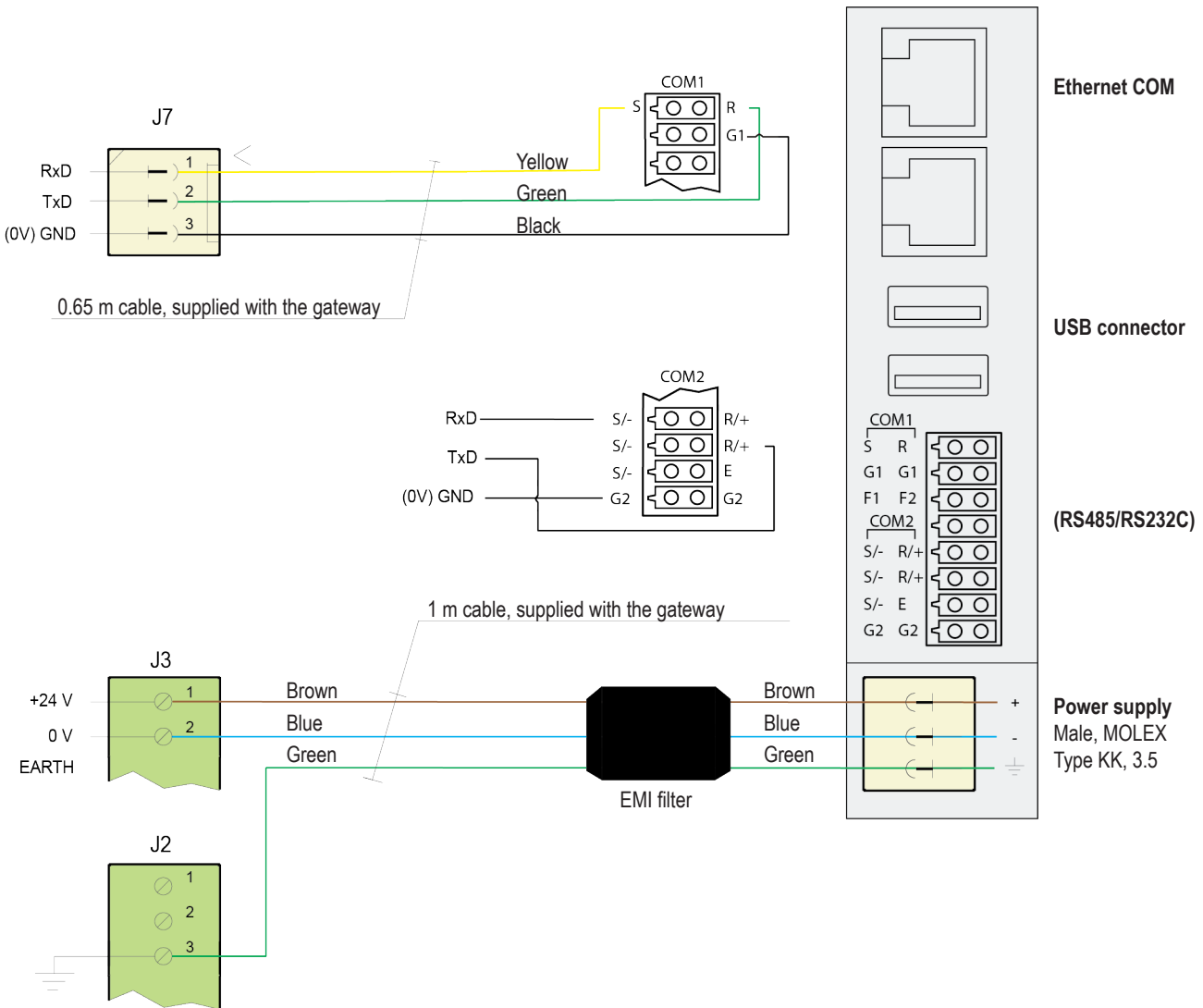

The gateway does not support using hardware flow control, such as RTS/CTS or DTR/DSR. In the client side, the hardware flow control should not be used, i.e. set hardware flow control settings to NONE. If there is no settings for hardware flow control, a solution may be to shortening the signals for RTS to CTS, or DSR to DTR.

11.1.2. MAIN BOARD 5012

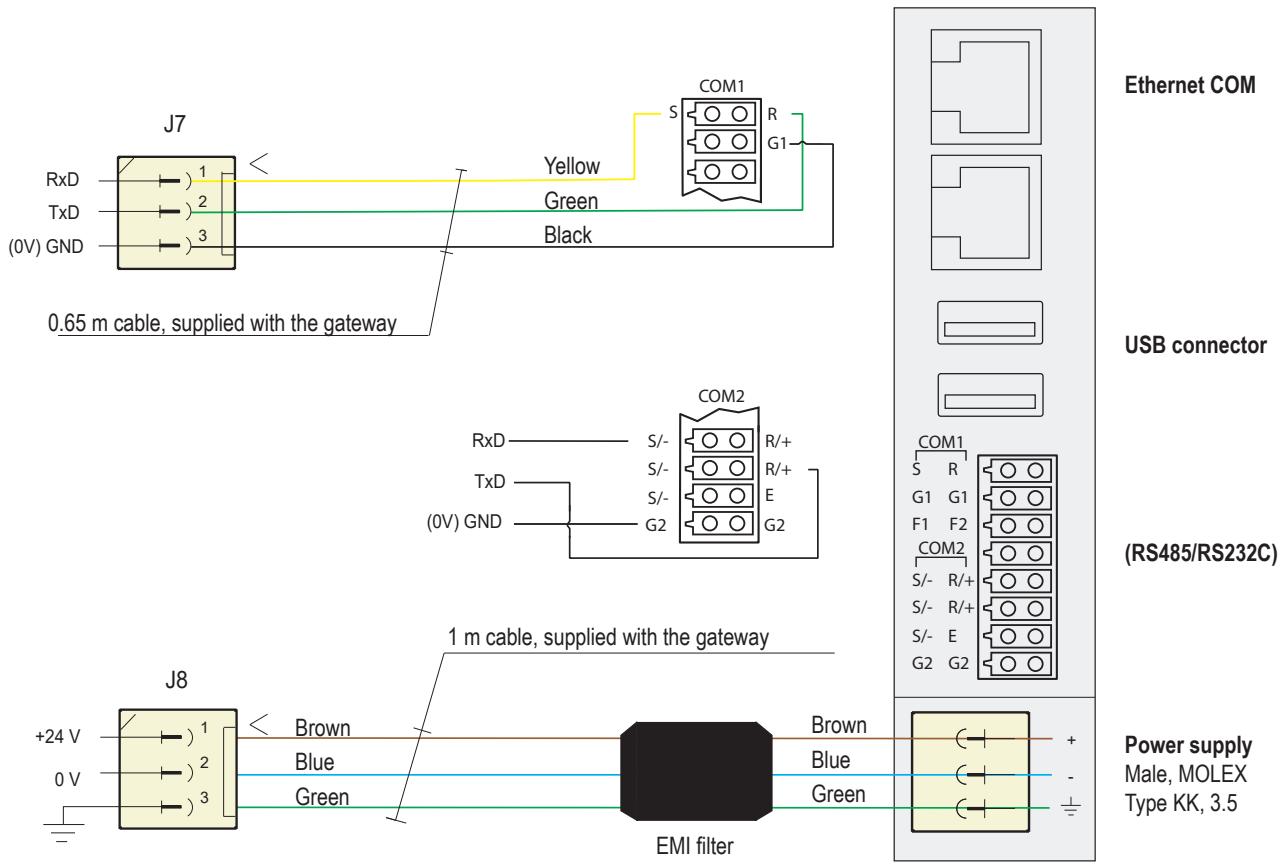

The gateway does not support using hardware flow control, such as RTS/CTS or DTR/DSR. In the client side, the hardware flow control should not be used, i.e. set hardware flow control settings to NONE. If there is no settings for hardware flow control, a solution may be to shortening the signals for RTS to CTS, or DSR to DTR.

11.2.EBLONE

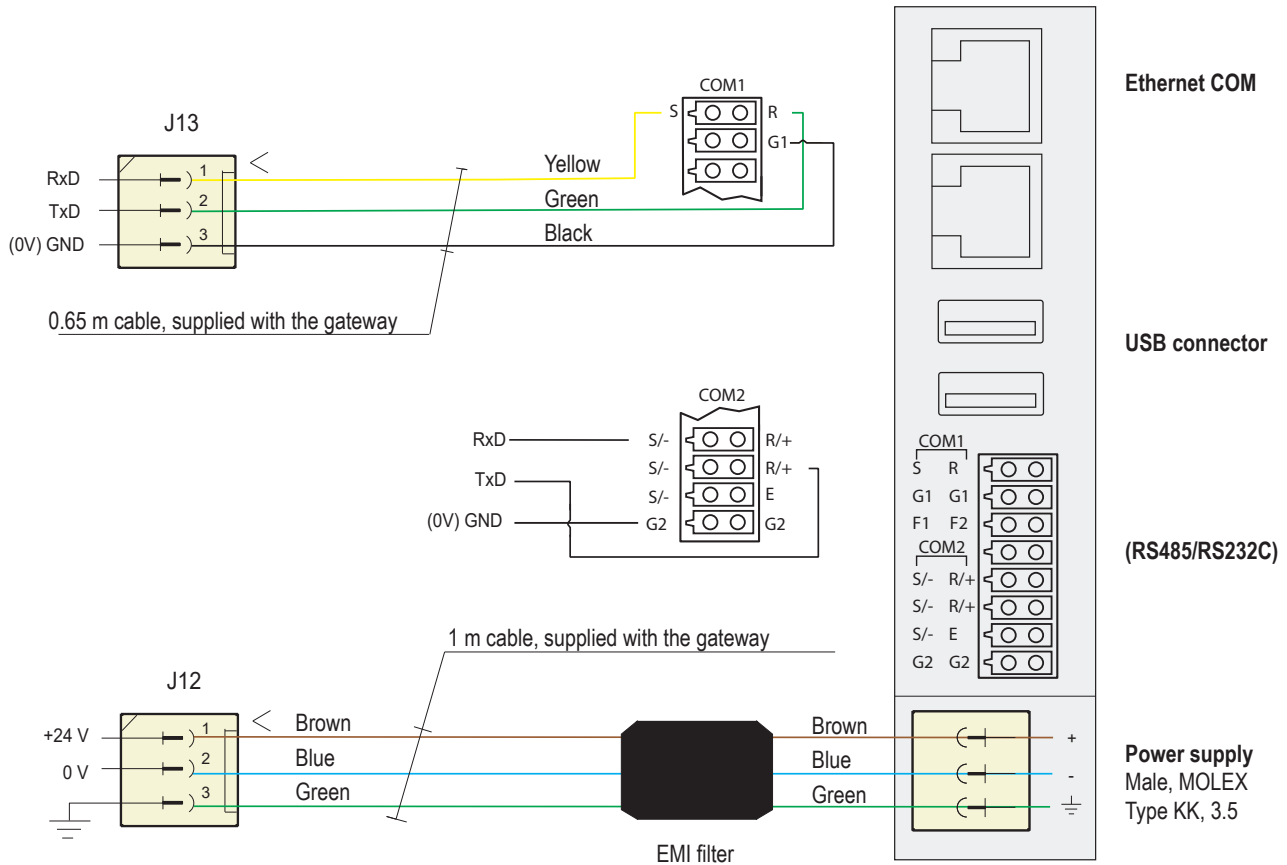

11.3.CHECKLIST

- Are the connectors firmly connected
- Are the connectors properly connected with respect to their voltage and polarity
- Are the cables securely fixed

12. COMMISSIONING

This chapter describes the correct sequence to install and set the gateway.

Make sure to read the complete technical description before commissioning the system.

PREPARATIONS AND MOUNTING

- a) Mount the gateway on the DIN rail inside the CIE. The length of the attached cables is 3 meters.

CONNECTIONS

- b) Connect the cables according to [11. INSTALLATION AND WIRING](#) on page 49.

SETTING OF IP ADDRESS AND CONFIGURATION

- c) Set the IP address with the Setup wizard, see section [7.2.1. SETUP WIZARD](#) on page 15.
- d) Download the EBLWeb software, see section [8.1.1. DOWNLOAD EBLWEB SOFTWARE](#) on page 26.
- e) Download the EBLWeb configuration, see section [8.2.1. DOWNLOAD EBLWEB CONFIGURATION](#) on page 27.
- f) Set the current timezone, see section [CURRENT TIMEZONE](#) on page 13.
- g) Download the SSD to the gateway.

13. TECHNICAL DATA

All current consumptions are valid by nominal voltage and by 25 °C.

Voltage: Allowed Normal	10.8 – 30.0V DC 24V DC
Current: Quiescent Active	75 mA 75 mA
Short circuit isolator	No
Internal battery	No
Material	FR ABS and polycarbonate
Ambient temperature: Operating Storage	0 to +55 °C -20 to +70 °C
Ambient humidity	Maximum 95 % RH (Non condensing)
Ingress protection rating	IP20
Size: H x W x D	90 x 25 x 74 mm
Weight	86 g
Colour	Black

14. APPROVALS

Applicable directive/ Approval	Applicable standards	Notified body
EMC	EN 61326-1:2013 (Emission & Immunity)	Declaration made by manufacturer (Panasonic Electric Works Europe AG)
RoHS	EN IEC 63000:2018	



DOCUMENT NAME: TECHNICAL DESCRIPTION GATEWAY
DOCUMENT NUMBER: MEW02670
DATE OF ISSUE: 2020-11-11
REV: 8
DATE OF REVISION: 2026-05-28

Panasonic Fire & Security Europe AB

Jungmansgatan 12
SE-211 11 Malmö
SE
Tel: +46 (0)40 697 70 00