



# AE2010G-P AE2010G-S

## ASPIRATING SMOKE DETECTOR

Fire alarm solutions  
technical description

# Table of Contents

<b>1.</b>	<b>INTRODUCTION</b>	5
<b>2.</b>	<b>ABBREVIATIONS AND EXPLANATIONS</b>	6
<b>3.</b>	<b>GENERAL DESCRIPTION</b>	7
3.1.	ASPECT TYPES AND SENSORS	8
3.2.	GRIZZLE	9
3.2.1.	GRIZZLE FRONT	9
3.3.	STAND-ALONE	10
3.3.1.	STAND-ALONE FRONT	10
3.4.	FIRE ALARM	11
3.5.	SERVICE SIGNAL	11
3.6.	CALIBRATION FAULT	11
3.7.	FAULT	11
3.8.	DISABLEMENT	12
<b>4.</b>	<b>ASPECT TOOL B</b>	13
4.1.	INSTALL ASPECT TOOL B – ANDROID	13
4.2.	INSTALL ASPECT TOOL B – IPHONE	13
4.3.	GET STARTED	14
4.4.	CONNECT TO ASPECT	15
4.4.1.	CONNECT TO A NEW ASPECT	16
4.5.	ASPECT TOOL B MENUES	17
4.6.	CHANGE SETTINGS IN ASPECT TOOL B	18
4.6.1.	DASHBOARD	19
4.6.2.	SENSITIVITY	20
4.6.3.	FLOW	21
4.6.4.	SIGNALING	23
4.6.5.	POWER	23
<b>5.</b>	<b>ASPECT TOOL</b>	24
5.1.	INSTALL ASPECT TOOL – ANDROID	24
5.2.	INSTALL ASPECT TOOL – IPHONE	24
5.3.	GET STARTED	25
5.4.	CONNECT TO ASPECT	26
5.4.1.	TROUBLESHOOT WIFI CONNECTION	27
5.4.2.	CONNECT TO A NEW ASPECT	28
5.5.	ASPECT TOOL MENUES	29
5.5.1.	STATUS READOUTS, GREEN ZONE	30
5.5.2.	CONFIGURE ASPECT, RED ZONE	33
5.5.3.	EDIT USER INFORMATION	36
<b>6.</b>	<b>ASPECT ACCESSORIES</b>	37
6.1.	ELOVAC	37

6.2.	THUB	37
6.3.	VULCAN	38
6.4.	POWERHOUSE	39
6.5.	SNIFFER	40
6.6.	DIAMANT	41
6.7.	EXHAUST KIT	41
6.8.	CONDENSE BOTTLE	42
6.8.1.	LK 501 - CONDENSE BOTTLE WITH UV-STABILISER	42
6.9.	ELOCLEAN	43
6.10.	PIPELINE PARTS	47
6.11.	ELOCUT2	48
6.12.	BATTERY - BA 1800	49
<b>7.</b>	<b>SPECIAL APPLICATIONS</b>	<b>50</b>
7.1.	GREENHOUSES	50
7.2.	POULTRY AND PIG FARMS	51
7.3.	CHURCHES	52
7.4.	COLD STORAGE	53
7.5.	DUSTY ENVIRONMENTS	53
<b>8.</b>	<b>INSTALLATION</b>	<b>54</b>
8.1.	PLANNING	54
8.1.1.	CABLE	54
8.1.2.	PIPES	54
8.1.3.	PIPEDRAW	55
8.1.4.	PIPE LAYOUT	57
8.2.	MOUNTING	59
8.2.1.	DRILLING SAMPLING HOLES	60
8.2.2.	THUB	61
8.2.3.	ELOCLEAN	62
8.2.4.	PIPE ENTRY	63
8.3.	ASPECT	66
8.3.1.	OPENING THE ASPECT	66
8.3.2.	MAINS CONNECTION	67
8.3.3.	BATTERY CONNECTION	68
8.3.4.	BACKUP BATTERY	68
8.3.5.	BATTERY BACKUP TIME	69
8.4.	CONFIGURATION	71
8.4.1.	EBLWIN FOR EBL512 G3 and EBLOne	71
8.4.2.	WIN512 FOR EBL512	74
8.5.	SET THE COM LOOP ADDRESS	75
8.5.1.	SET THE MODE	75
8.6.	WIRING	76
8.6.1.	GRIZZLE	76
8.6.2.	STAND-ALONE	77
8.7.	CALIBRATION	78
<b>9.</b>	<b>MAINTENANCE</b>	<b>79</b>
9.1.	SERVICE INTERVAL	79

9.2.	ANNUAL INSPECTION	80
9.2.1.	FUNCTIONAL TEST	81
9.2.2.	FUNCTIONAL TEST STAND-ALONE	81
9.2.3.	REPLACING THE MAIN FILTER	82
9.2.4.	INSPECTION AND REPLACEMENT OF DIAMANT	83
9.2.5.	REPLACING THE SENSOR KIT	83
9.2.6.	RESET THE EVENT LOG	85
9.3.	TRANSITION FROM NITRO TO GRIZZLE SENSOR	86
9.3.1.	REPLACING ASPECT-WIFI WITH ASPECT-BLE	86
9.3.2.	INSTALLATION OF ASPECT-BLE	87
9.3.3.	CONVERSION PROCESS IN ASPECT TOOL B	88
<b>10.</b>	<b>COMMISSIONING THE ASPECT SYSTEM</b>	<b>89</b>
<b>11.</b>	<b>TECHNICAL DATA</b>	<b>90</b>
11.1.	GRIZZLE AND STAND-ALONE	90
11.2.	ELOCLEAN	91
<b>12.</b>	<b>APPENDIX</b>	<b>92</b>
12.1.	ASPECT CPU BOARD	93
12.2.	ADDITIONAL CIRCUIT BOARDS	94
12.3.	PROGRAM PARAMETERS	95
12.3.1.	PROGRAM PARAMETERS WITHOUT ASPECT TOOL	97
12.4.	SERVICE CODES	98
12.4.1.	READ OUT SEVICE CODES WITHOUT THE ASPECT TOOL	100
<b>13.</b>	<b>APPROVALS</b>	<b>101</b>

# 1. INTRODUCTION

This document describes the ASPECT 2010 series of aspirating smoke detectors (integrated by Panasonic).

Panasonic's Control and indicating equipment (CIE) makes it easy to integrate the ASPECT with Panasonic's fire alarm systems.

## 2. ABBREVIATIONS AND EXPLANATIONS

<b>CIE</b>	Control and indicating equipment	= control unit
<b>dB</b>	Decibel	
<b>LED</b>	Light Emitting Diode	
<b>Grizzle range</b>	Grizzle sensor is an optic sensor with the range of visible smoke.	
<b>Nitro range</b>	Nitro sensor is an ionizing sensor with the range of smoke and gases.	

### 3. GENERAL DESCRIPTION

The Aspect consists of a cabinet with a built-in fan, filters, and chambers for smoke detection. Grizzle has two detection chambers. Naturally occurring gases, particles and condensation are separated from fire gases and smoke before detection takes place. The Aspect is manufactured in an anodized aluminum alloy specially developed to maintain its good look even after extended use in all kinds of environments. The top and bottom parts are made of PC/ABS. The closed housing with overpressure ensures that dust and moisture do not reach the electronics.

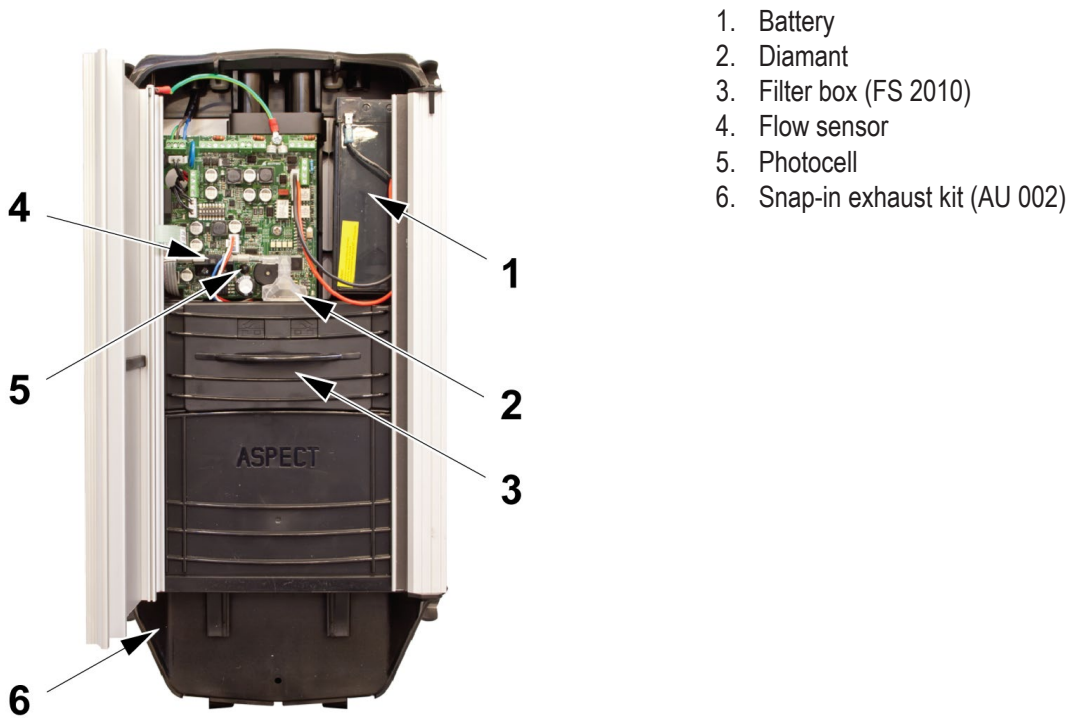

- The Aspect has a built-in power supply and is to be connected to the mains.
- The Aspect has room for a 7 Ah, or a 18Ah (LiFePO4), built in battery, as a back-up power source. It can however be powered by an external 24 V supply. If more battery capacity is needed, up to 24 Ah can be connected in accordance with EN-54. We recommend using PowerHouse for external batteries.
- The DIAMANT is a filter module for protection of the flow sensor.
- Airflow is constantly monitored in order to reveal problems with filters or pipes.
- The snap-in exhaust kit leads the exhaust away from the Aspect. The exhaust kit can also be installed to reduce noise from the Aspect.

The aspirating fan and housing are designed to balance effect and noise, which makes the Aspect one of the most silent aspirating smoke detectors available.

- Human speech produces approximately 60 dB, an Aspect with standard settings produces 55 dB.
- The noise level can be lowered further (5-10 dB) by installing the exhaust kit AU 002.

### 3.1. ASPECT TYPES AND SENSORS

Type number	Sensor spare part number	Sensor type included
AE2010G-P	SENSORKIT-G	Grizzle B/C
AE2010GH-P	SENSORKIT-GH	Grizzle B+/B
AE2010GN-P	SENSORKIT-GN	Grizzle C/C-
AE2010G-S	SENSORKIT-G	Grizzle B/C

## 3.2. GRIZZLE

Grizzle provides early detection of visible smoke, even in extremely dusty environments. The Grizzle sensor accepts gases that normally occur in the detection zones without giving unwanted alarms, while maintaining the required sensitivity according to EN54-20, classes B and C.

Grizzle has two detection chambers. Pipe 1 leads air to sensor 1 and pipe 2 leads to sensor 2.

### 3.2.1. GRIZZLE FRONT

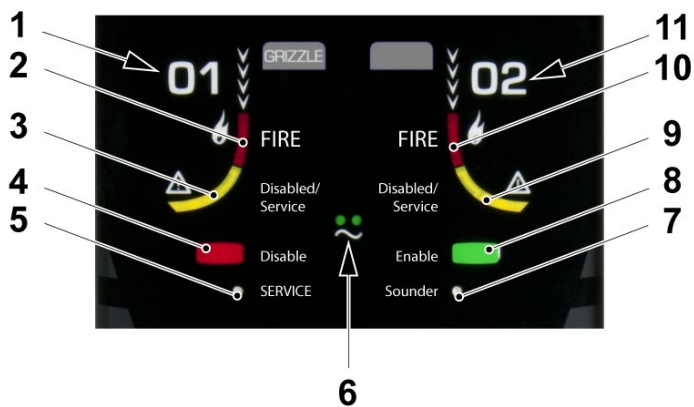

1. Sensor area 1
2. Red LED on – Smoke detected in area 1
3. Yellow LED Flashing – Area 1 disabled Yellow LED on – Replace sensor kit
4. Red button – Disable Aspect (both areas). See section 3.9 DISABLEMENT.
5. Service LED on – Generic service message (specified in event log).
6. Green Power LEDs on – Normal operation Green Power LEDs off – Mains power is missing Green Power LEDs flashing – Abnormal condition, battery or charger (specified in event log).
7. Sounder LED – Not in use
8. Green button – Enable Aspect (Activate Wifi).
9. Yellow LED Flashing – Area 2 disabled Yellow LED on – Replace sensor kit
10. Red LED on – Smoke detected in area 2
11. Sensor area 2

The buttons/LED:s can also be use to read out faults without the Aspect tool, see section [12.3. PROGRAM PARAMETERS on page 95.](#)

### 3.3. STAND-ALONE

The stand-alone Aspect is connected to a conventional zone line input, via 4461. The control unit will receive faults and fire signals but will not be able to distinguish between zone 1 and zone 2. For information about which zone, you must see the stand-alone Aspect front. Detailed information about fire and faults can be read out from the Aspect tool.

The stand-alone Aspect has the same fire detection functionality as Grizzle, and provides early detection of visible smoke, even in extremely dusty environments.

#### 3.3.1. STAND-ALONE FRONT

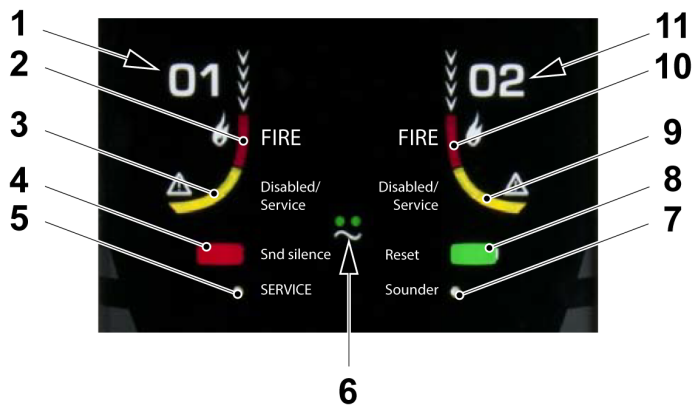

1. Sensor area 1
2. Red LED on – Smoke detected in area 1
3. Yellow LED Flashing – Area 1 disabled Yellow LED on – Replace sensor kit
4. Red button – Deactivate the integrated sounder output
5. Service LED on – Generic service message (specified in event log).
6. Green Power LEDs on – Normal operation Green Power LEDs off – Mains power is missing Green Power LEDs flashing – Abnormal condition, battery or charger (specified in event log).
7. Sounder LED – Not in use
8. Green button – Reset the Aspect
9. Yellow LED Flashing – Area 2 disabled Yellow LED on – Replace sensor kit
10. Red LED on – Smoke detected in area 2
11. Sensor area 2

The buttons/LED:s can also be use to read out faults without the Aspect tool, see section [12.3. PROGRAM PARAMETERS on page 95.](#)

### 3.4. FIRE ALARM

When the Aspect is in fire alarm state, the red LED on the front of the Aspect will start flashing, and the Aspect will directly send the fire alarm information to the CIE “Fire alarm” will be activated and displayed in the CIE.

The fire alarm is reset via the CIE reset button.

### 3.5. SERVICE SIGNAL

A service signal will be activated in the CIE when one or both sensors are contaminated.

Service codes 7 and 8 will be activated in the Aspect tool. Replace the sensor kit in the Aspect.

*It is NOT possible to read out the sensor values of the Aspect in the CIE menu H4/U4.*



For more information on Aspect tool see [5. ASPECT TOOL on page 24.](#)

### 3.6. CALIBRATION FAULT

A “Calibration fault” will be activated in the CIE. if the Aspect needs to be calibrated.

Service code 2 will be activated in the Aspect tool.

### 3.7. FAULT

A fault will be activated in the CIE if a fault occurs in the Aspect. Connect the Aspect Tool to identify what the actual fault is. In the Aspect Tool press  and then press  to go into the Service Log tab, to see a list of the latest faults. As this is only a log, you will not see the current status of the fault here.

The status of the faults (Serviced/Acknowledged) are shown in the CIE.

See also [12.4. SERVICE CODES on page 98.](#)

Fault message in c.i.e:

```

FAULT: Aspect zone: xxx address: xx and
zone: xxx address: xx
Technical number xxxxxx
Aspect Grizzle 01
2021-04-03 15:22      /Serviced
    
```

Number of faults in system: 5

Menu

It is also possible to identify a fault by the LEDs on the Aspect front. See each front respective in section [3. GENERAL DESCRIPTION on page 7](#)

When the fault has been corrected, the fault LED on Aspect will go out. The CIE will present the fault as “serviced”.

It is also possible to identify the actual fault without Aspect Tool, see section [12.4. SERVICE CODES on page 98.](#)

## 3.8. DISABLEMENT

The Aspect can always be disabled via the CIE.

To be able to disable via the Aspect front, the aspect needs to be configured in EBLWin.

This also means that the setting option "P11 – Disablement duration" in Aspect tool is not used.

This duration time is only set in EBLWin.

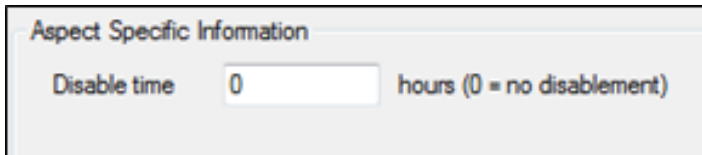

Aspect Specific Information

Disable time  hours (0 = no disablement)

See chapter [8.4. CONFIGURATION](#) on page 71.

## 4. ASPECT TOOL B

Aspect tool B is available to download. This is a newer app than Aspect tool, which has support for BLE (bluetooth connection). Due to continuous development, make sure to always update to the latest app version.

Aspects produced after 30:th of April year 2021 (serial number xx2118xxx or higher) has support for BLE, and Aspect will by default communicate with BLE if you connect with Aspect tool B.

Aspect tool B is compatible with Android 12 and later. It is available for Android and iOS.

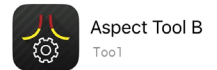

### 4.1. INSTALL ASPECT TOOL B – ANDROID

To install the Aspect Tool app search for Elotec in the Google Play store. Select the Aspect Tool app, and press “Install”. Accept the permissions requested by the app. The e-mail address is used for licensing.

*It is recommended to activate automatic updates to ensure that you always use the most recent version.*

### 4.2. INSTALL ASPECT TOOL B – IPHONE

To install the Aspect Tool app search for Elotec in the App Store. Select the Aspect Tool app, and press “Get”. Open the app and enter the user information. The e-mail address is used for licensing.

*It is recommended to activate automatic updates to ensure that you always use the most recent version.*

## 4.3. GET STARTED

When you start the Aspect Tool B for the first time and press one of the icons, you will be asked to fill in some user information.

*No operations are available until you have filled in your name, company and e-mail address.*

- a) The "Account info" button is your starting point. Enter your information.
- b) Press save.
- c) Enter your License Key. (As a Panasonic customer, contact Panasonic if you want to buy an access key.)
- d) Press "Initiate connection to Aspect".
- e) "Disconnected" symbol indicate that connection has not been established. The first time you press "Initiate connection to Aspect", you will be asked if you want to run in demo mode or buy an access key.

Remember to supply the e-mail address shown in the field "Account ID" under user information. The key is time limited from the date of purchase. Example: A key with number 230617-XXX will be valid until year 2023, month 06, day 17.

*Remember to write down the code in case you switch phones during the lifetime of the key.*

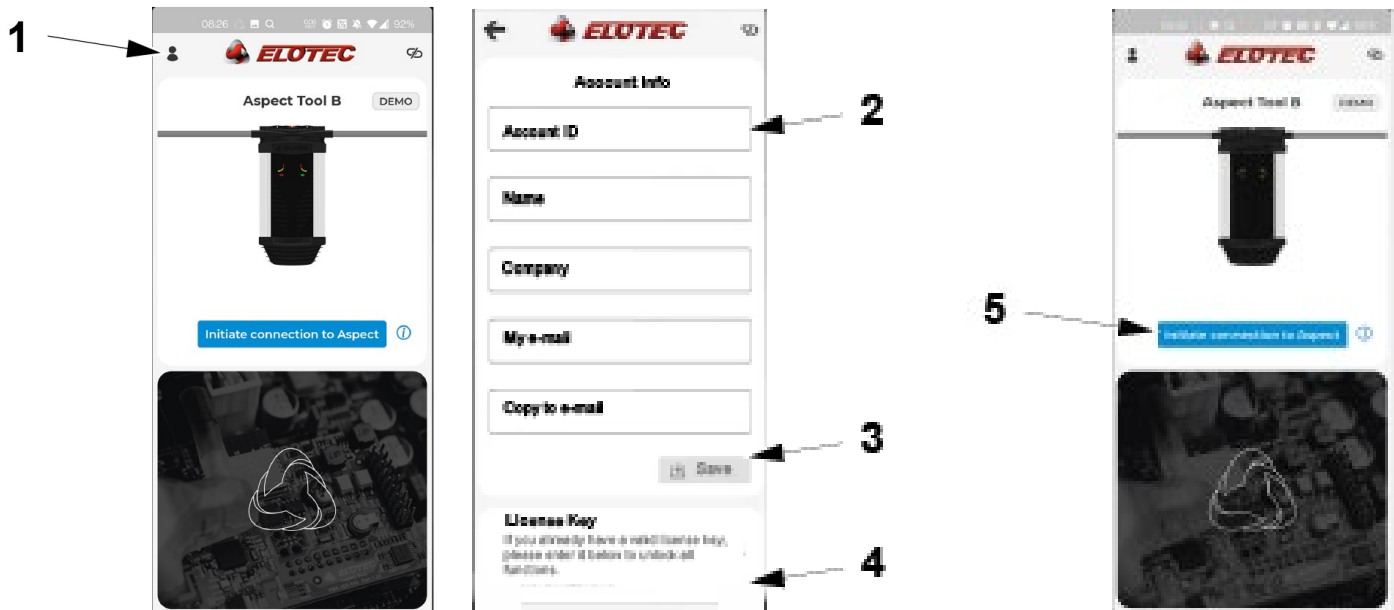

1. Account info

2. Account ID=The e-mail address which is registered with the License key
3. Save
4. Enter License Key

5. Initiate connection to Aspect

## 4.4. CONNECT TO ASPECT

If the Aspect has support for BLE, it will by default communicate with BLE if you connect with Aspect tool B. Make sure bluetooth is turned on.

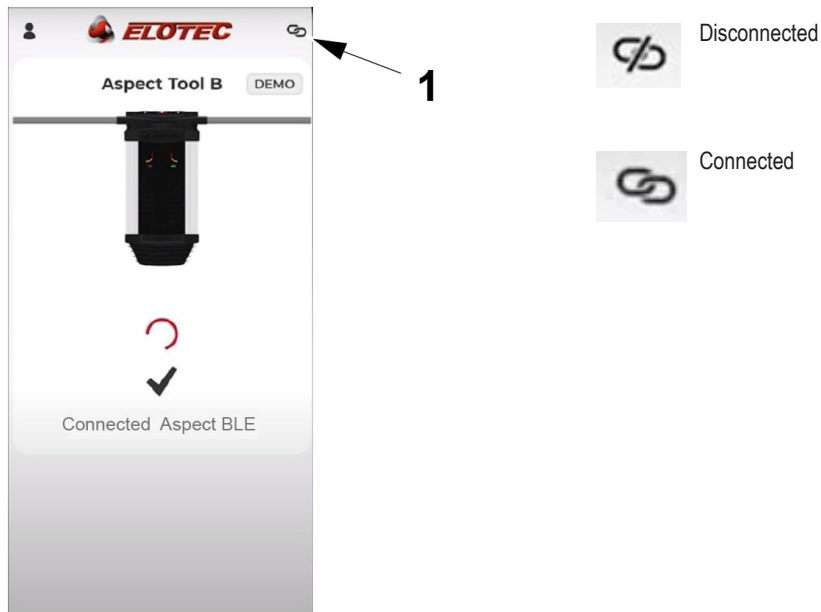

1. Connection symbol

If your Aspect is produced before 30:th of April year 2021: Start by browsing for available Wi-Fi connections and select "Aspect\_Wi-Fi". Press "Open Wi-Fi settings" and connect to the wireless network "Aspect\_Wi-Fi". Then, press the back-button of your device to return to Aspect Tool.

If the network "Aspect\_Wi-Fi" is not displayed, activate the Wi-Fi module in the Aspect by opening the door and pressing the green button in front. The blue LED should light up on the CPU board.

Press the button "Initiate connection to Aspect".

When connection with Aspect has been established, the message "Connected to Aspect..." will show..

See section [5.4.1. TROUBLESHOOT WIFI CONNECTION](#) on page 27.

## 4.4.1. CONNECT TO A NEW ASPECT

You will be asked to register system data when the app connects to an Aspect device it has not previously been connected to.



The screenshot shows the 'New Aspect' registration screen in the ELOTEC app. At the top, there is the ELOTEC logo and the title 'New Aspect'. Below the title is a central image of a black smoke detector. Underneath the image are four input fields: 'Project name', 'Customer name' (with 'New Customer' entered), 'Address' (with 'Solveien' entered), and 'Post code' (with '7391' entered). A 'Save' button is located at the bottom right of the form.

- a) Register the Project name. Use a description that will allow you to recognize the installation later. If you enter a known customer in the previous stage, existing projects registered on the same customer will be suggested.
- b) Register the name of the customer.
- c) Address of the site.
- d) Postcode of the site.
- e) Press Save
- f) After this, it's recommended to make the calibration.

When pressing save, the date for the next battery replacement is set automatically to 3 years.

The information that is added for a new Aspect is stored in the Aspect.

The next person arriving to the installation do not have to enter this information again.

## 4.5. ASPECT TOOL B MENUES

The following view is displayed when you start the app. Here, you will find icons to access the different functions.

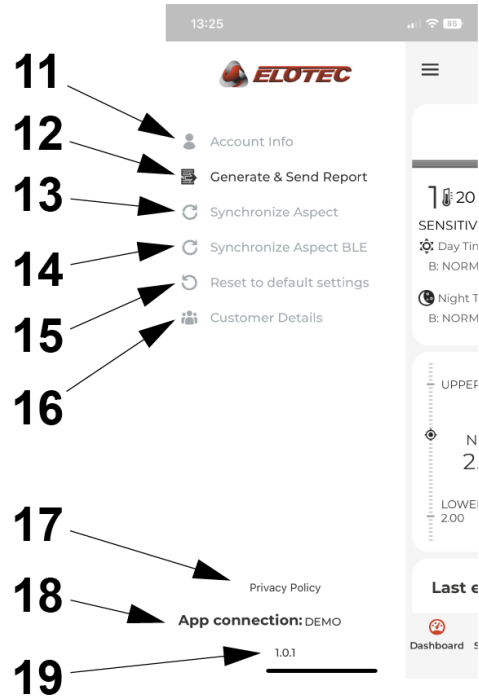

- |  |  |
|--|--|
| <ol style="list-style-type: none"> <li>1. Dashboard</li> <li>2. Sensitivity</li> <li>3. Flow</li> <li>4. Signaling</li> <li>5. Power</li> <li>6. Event log</li> <li>7. "i" information about the connected Aspect unit</li> <li>8. Connected/unconnected to Aspect</li> <li>9. Locked for editing</li> <li>10. "More menus"</li> </ol> | <ol style="list-style-type: none"> <li>11. Account Info</li> <li>12. Generate &amp; Send Report</li> <li>13. Synchronize Aspect</li> <li>14. Synchronize Aspect BLE</li> <li>15. Reset to default settings</li> <li>16. Customer Details</li> <li>17. Link to Privacy Policy</li> <li>18. Name of the connected Aspect unit; entered as "Project name" the first time you register the Aspect.</li> <li>19. Aspect tool version for Android and iOS</li> </ol> |
|--|--|

## 4.6. CHANGE SETTINGS IN ASPECT TOOL B

To make changes in the Aspect tool B, press a setting value. A pop up window will ask if you want to unlock the settings. Press "unlock". Change the settings and press save.

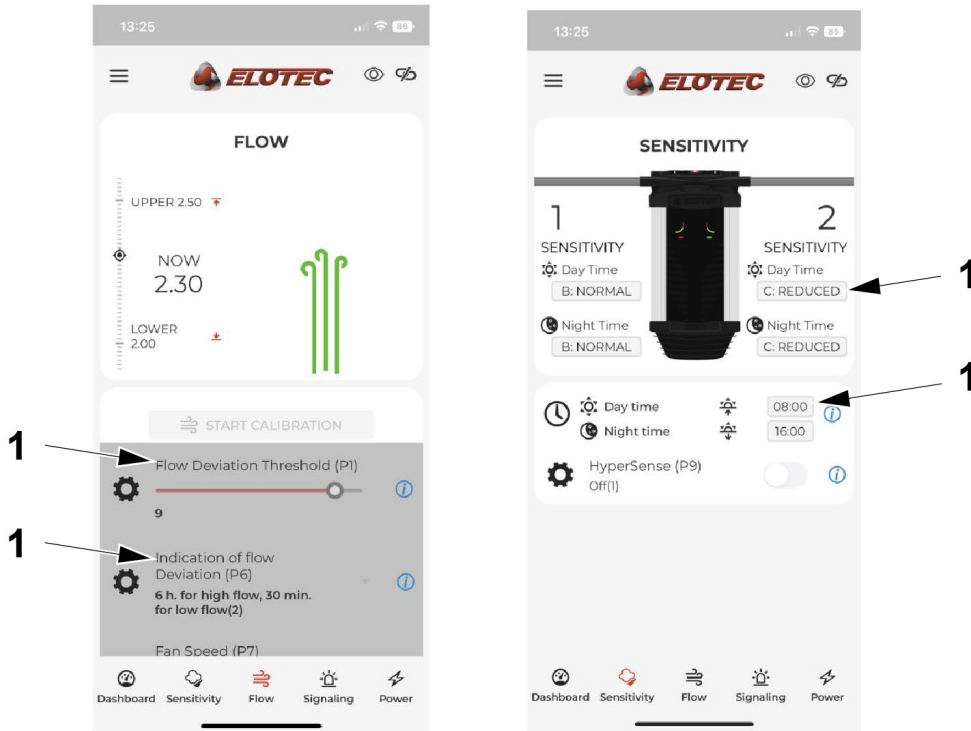

1. Examples of "Setting values" - click text or clickable area to make changes.

## 4.6.1. DASHBOARD

Graphic presentation of airflow and limit values.



### 4.6.1.1 EVENT LOGS

In the bottom of the Dashboard page, you will find "Last event". Press text or symbol to view the event log.

The Event logs view will show the latest service message, latest alarm and latest configuration change. Date and time of the event.

For more information about the service codes, see [12.4. SERVICE CODES](#) on page 98.

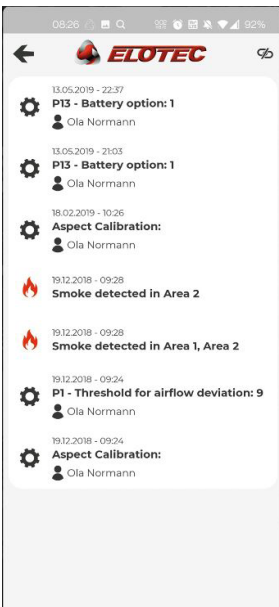

## 4.6.2. SENSITIVITY

Sensitivity can be set per area, and it is possible to differentiate between night and day. Press the sensitivity indication to cycle through available options. The options will differ depending on what sensor kit is installed.

Press the sun or moon icons to change the starting time of day and night respectively.

The Hypersense (P9) will increase the sensitivity when activated. Default setting: 1 = Off

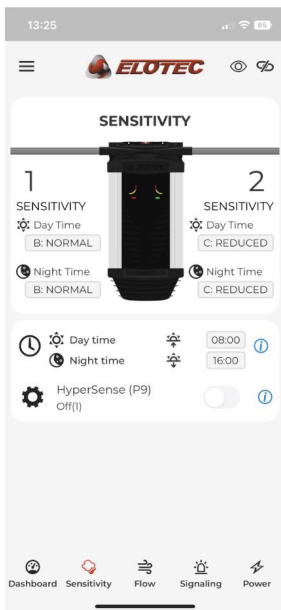

### 4.6.3. FLOW

Graphic presentation of airflow and limit values.

#### Start Calibration

After all connections have been made, the Aspect must be calibrated to the correct air flow. Tolerance to and warning of changes in the air flow must be adapted to the building mass and usage. To be able to calibrate, the fan in the Aspect must be running, and the flow value must be above 1,6 H<sub>2</sub>O.

LOWER / UPPER are the limits set in (P1) for flow deviation tolerance.

The time it takes to receive the indication of flow fault is set in program parameter (P6).

Fan speed adjustment (P7). Default /recommended speed: 10

#### P10

P10 has different choices of auto calibration during start-up.

- (1) Aspect uses 48 hours to calculate / stabilize the flow window.
- (2) Aspect uses 7 days to calculate / stabilize the flow window.
- (3) Aspect uses longer time to calculate / stabilize the flow window. It is also based on the different seasons during the year, adapted for green houses.

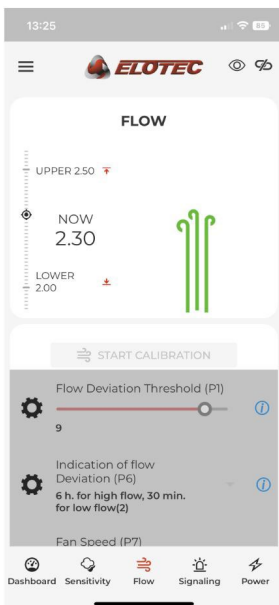

***P10 is only active when P1=1, all other settings of P1 makes P10 inactive.***

***Calibration should only be carried out while pipelines and filters are clean, so that the Aspect has normal operating conditions. Calibration during abnormal conditions will give the Aspect a faulty baseline for monitoring, and will lead to unnecessary service messages.***

Calibration should only be carried out when:

- Commissioning a new installation of Aspect
- Filter TYPE is changed
- Environment has changed to other type of activity
- Changes of the pipe line design

### 4.6.3.1 AIR FLOW

#### FAN SPEED ADJUSTMENTS

For class A and B installations, the fan speed must always be set to maximum (10).

For class C it can be reduced, in order to reduce the noise, or if the pipes are very short. The most important is that the sensitivity of each hole is within the requirements and that the response time is also within the requirements. Make a smoke test in the last hole on the pipeline and verify that the transportation time is within 120 seconds according to EN54. Or transportation time according to local regulations.

The following configurations are acceptable.

Fan speed	4	7	10
Maximum pipe length	40 m	60 m	100 m
Maximum holes per pipe	6	8	10
Minimum vacuum in last hole			
1 pipe total (using THUB)	0.75 cmH2O		
2 pipes total (1 per area)	1 cmH2O		
Noise reduction	5 dB	2.5 dB	--

***For installations with more than one pipe per area (using THUB), fan speed must always be 10.***

***PipeDraw is always calculating with fan speed 10.***

***Fan speed changes immediately on the Aspect when you move the P7 slider. You still need to press the diskette icon (save) to make the change permanent.***

## 4.6.4. SIGNALING

This view displays settings for signaling.

- Aux input function (P3)
- Signaling on loop when disabled (P8)
- Disabling duration (Stand alone only) (P11)

For more information about the program parameters, see [12.3. PROGRAM PARAMETERS](#) on page 95.

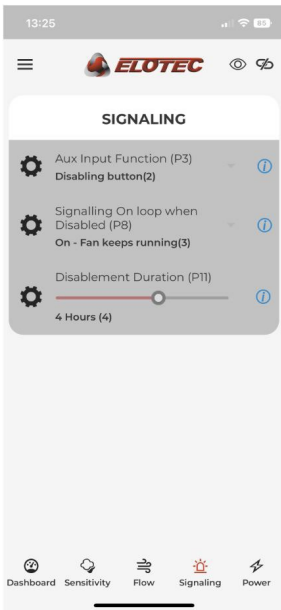

## 4.6.5. POWER

This view displays settings for power, and information about next battery replacement.

- Power supply (P2)
- C- filter during mains fault (P4)
- Indication of mains outage (P5)
- Battery Option (P13)

For more information about the program parameters, see [12.3. PROGRAM PARAMETERS](#) on page 95.

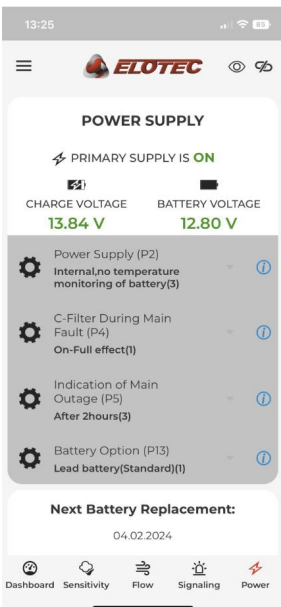

## 5. ASPECT TOOL

For easy commissioning, configuration and service, the app Aspect Tool is used. It is available for Android and iOS, and communicates with the built-in Wi-Fi diagnostics module.

**Aspect tool:** For technicians, this app is used for configuring and commissioning of the Aspect.

**Aspect tool B:** For technicians, this app is used for configuring and commissioning of the Aspect.

See chapter 4. ASPECT TOOL B on page 13.

**Aspect View:** View only.

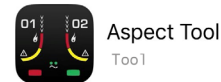
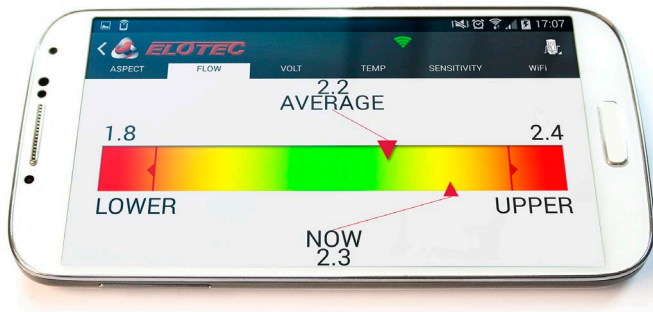

### 5.1. INSTALL ASPECT TOOL – ANDROID

To install the Aspect Tool app search for Elotec in the Google Play store. Select the Aspect Tool app, and press “Install”. Accept the permissions requested by the app. The e-mail address is used for licensing.

Aspect tool is not compatible with Android 12 or later. (Use Aspect tool B, or older smart phone).

*It is recommended to activate automatic updates to ensure that you always use the most recent version.*

### 5.2. INSTALL ASPECT TOOL – IPHONE

To install the Aspect Tool app search for Elotec in the App Store. Select the Aspect Tool app, and press “Get”. Open the app and enter the user information (red zone). The e-mail address is used for licensing.

*It is recommended to activate automatic updates to ensure that you always use the most recent version.*

## 5.3. GET STARTED

When you start the Aspect Tool for the first time and press one of the icons, you will be asked to fill in some user information.

*No operations are available until you have filled in your name, company and e-mail address.*



The “Handshake” button is your starting point. White cuffs indicate that connection has not been established. The first time you press this, you will be asked if you want to run in demo mode or buy an access key.

Contact Panasonic if you want to buy an access key.

In order to connect to a physical Aspect device, you need a key. Press the button “Buy key” to unlock the app. A license key can be purchased in-app through Google Play. Remember to supply the e-mail address shown in the field “Account ID” under user information. The key is time limited from the date of purchase.

Example: A key with number 230617-XXX will be valid until year 2023, month 06, day 17.

*Remember to write down the code in case you switch phones during the lifetime of the key.*

## 5.4. CONNECT TO ASPECT

Start by browsing for available Wi-Fi connections and select “Aspect\_Wi-Fi”. When connection has been established, press the handshake button.

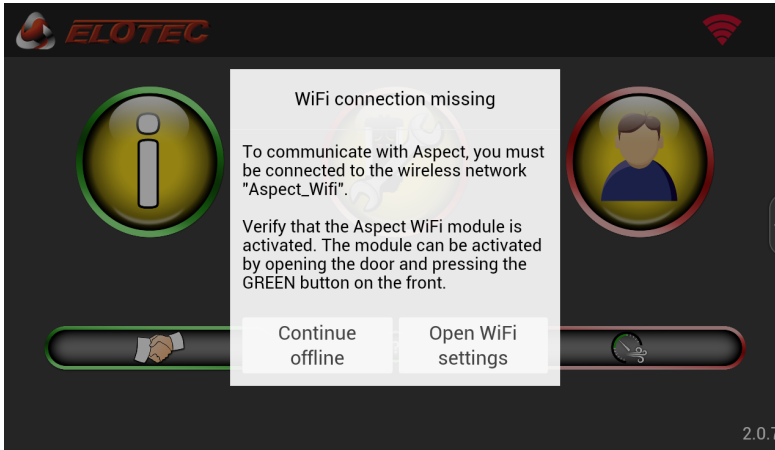

Press “Open Wi-Fi settings” and connect to the wireless network “Aspect\_Wi-Fi”. Then, press the back-button of your device to return to Aspect Tool.

The Wi-Fi symbol in the upper right corner should turn green - this symbol is visible in all views.



If the network “Aspect\_Wi-Fi” is not displayed, activate the Wi-Fi module in the Aspect by opening the door and pressing the green button in front. The blue LED should light up on the CPU board.

Press the “handshake” button.

When connection with Aspect has been established, the cuffs on the “handshake” button will turn green.



## 5.4.1. TROUBLESHOOT WIFI CONNECTION

*Tip 1: Turn off blue tooth on the phone.*

*Tip 2: Newer versions of Android and iOS requires that the Aspect tool has access to GPS data. That means that Location services / GPS location must be turned on. In addition, there is a feature called "Smart Network Switching" on Android and WiFi help on iOS that must be turned off.*

*Tip 3: Check that there are no other phones nearby, that have been connected to that Aspect, as the phones can re-connect automatically. If this is the case, try following steps:*

- a) Turn off WiFi on all other phones that been connected to that Aspect.
- b) Turn on WiFi on one phone, press green button on Aspect to activate WiFi.
- c) Go to settings / WiFi / Aspect WiFi in the phone, and select "forget this network".
- d) Connect to Aspect WiFi.
- e) Press handshake in Aspect tool.

In addition, there is a feature called "Smart Network Switching" on Android and WiFi help on iOS that must be turned off. It should be connected now. If not, se next step.

- f) Disconnect 230V and battery from Aspect.
- g) Re-connect battery.
- h) Try to connect to Aspect tool again.

## 5.4.2. CONNECT TO A NEW ASPECT

You will be asked to register system data when the app connects to an Aspect device it has not previously been connected to.

New Aspect
×

You need to register information about this Aspect for later use

---

Aspect number (in project):

Next

- a) Register the date of installation. The current date is automatically suggested.
- b) Set a date for the next battery replacement. We recommend that standard lead-acid batteries are replaced every three years.
- c) Register the name of the customer.
- d) Type a name for the project or installation. Use a description that will allow you to recognize the installation later. If you enter a known customer in the previous stage, existing projects registered on the same customer will be suggested.
- e) State who is responsible for the project. This could be your group leader, or an external consultant. Copy of system documentation will be sent to the e-mail address given here.
- f) Describe the location of the Aspect within the installation, so that you can easily find it again later.

The information that is added for a new Aspect is stored in the Aspect.

The next person arriving to the installation do not have to enter this information again.

## 5.5. ASPECT TOOL MENUES

The following view is displayed when you start the app. Here, you will find icons to access the different functions. The app has been divided into two zones – a “green zone” for safe readout of information, and a “red zone” for making changes to the Aspect. Also, on the start view, there is a separate button for initiating a connection with an Aspect, and a shortcut to the calibration view for ease of access during commissioning.

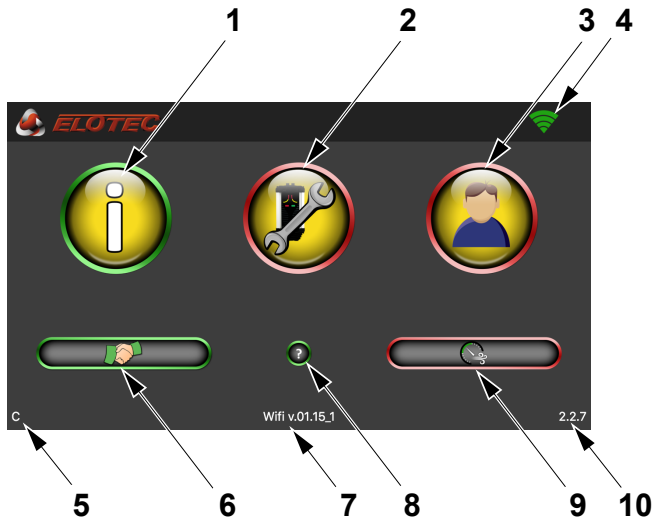

1. Status readouts, green zone
2. Configure Aspect, red zone
3. Edit user information, red zone
4. WiFi connected (green)
5. FW version for Aspect detector
6. Handshake / connection
7. FW version for Aspect WiFi board
8. Help
9. Shortcut to calibration
10. Aspect tool version for Android and iOS

## 5.5.1. STATUS READOUTS, GREEN ZONE

The green zone represents safe functions for readout. It is not possible to make any changes to the configuration of the Aspect in this zone.

This section describes how to read information from the Aspect by using the Aspect Tool app. These are safe operations that are carried out in the green zone of the app – no settings can be changed here.

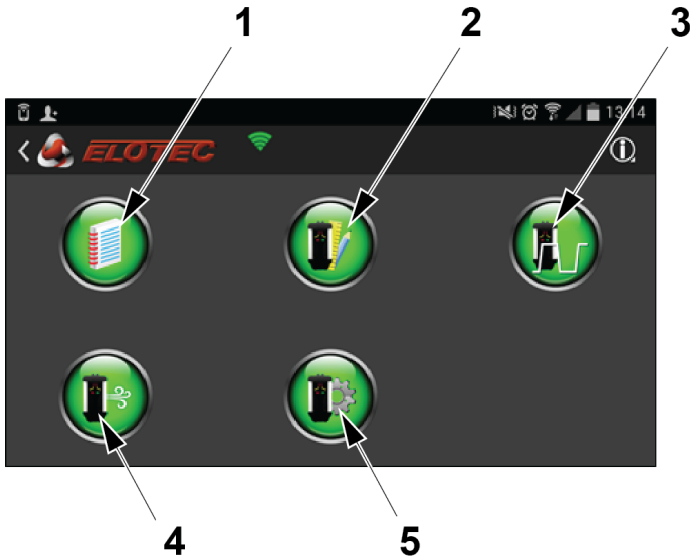

1. Event logs
2. Status information
3. Program parameters (air flow/disablement)
4. Program parameters (power/signaling)

### 5.5.1.1 EVENT LOGS

In the Aspect Tool press  and then press  :

The Event logs view has three tabs that show the latest service message, latest alarm and latest configuration change.

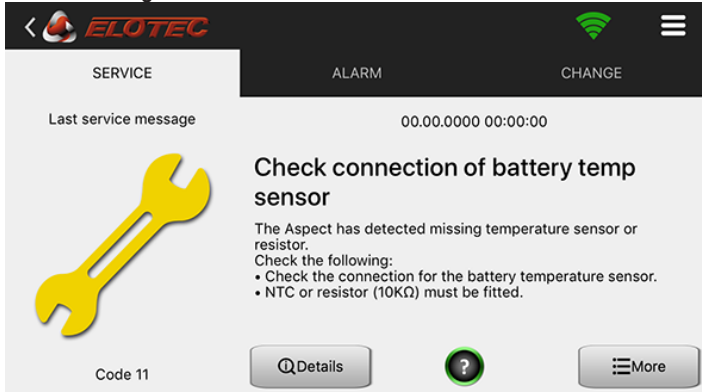

- The Detail button will display detailed information on system values at the time of the event.
- The More button leads to a combined list of all logged events.

For more information about the service codes, see [12.4. SERVICE CODES](#) on page 98.

### 5.5.1.2 STATUS INFORMATION - ASPECT TAB

In the Aspect Tool press  and then press  :

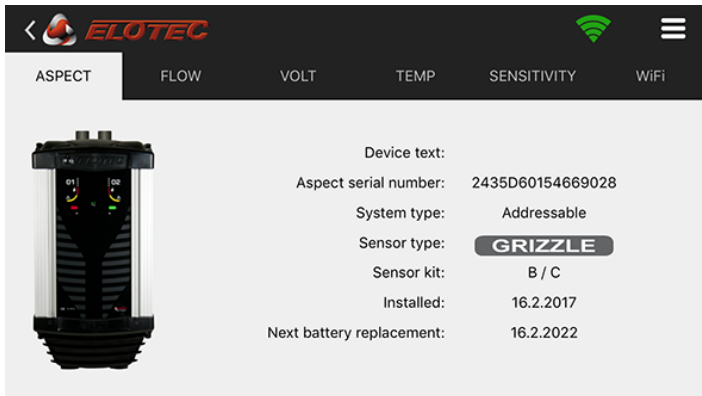

This tab displays an overview of useful information such as serial number, product variant and key dates.

### 5.5.1.3 STATUS INFORMATION - FLOW TAB

In the Aspect Tool press  and the press  :

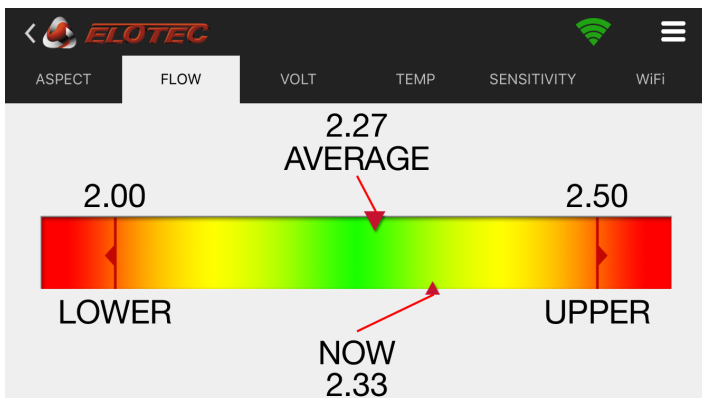

This tab displays an overview of air flow and calibrated thresholds.

It is recommended to write down these values. Check that the actual air flow is not too close to the thresholds for no reason. The Aspect door shall be closed during readout of flow values. The fan must be running.

The value AVERAGE is the mean flow value over the last 3 hours, and this is the value you should relate to in order to determine if conditions are OK / Aspect is correctly calibrated.

The value NOW is the real-time flow integrated over 10 seconds and will let you see continuous variations.

### 5.5.1.4 PROGRAM PARAMETERS – FLOW SETTING

In the Aspect Tool press  and then press  :

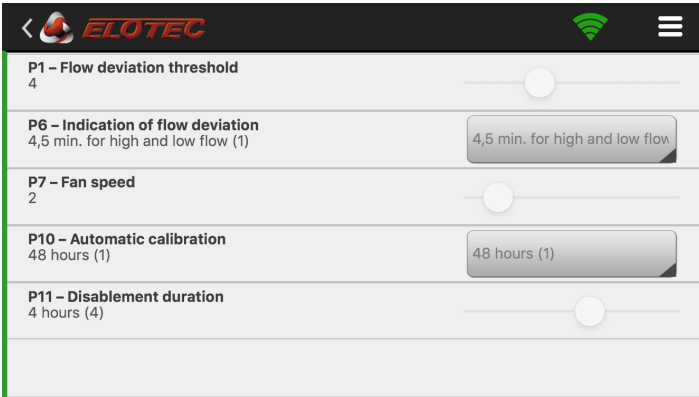

This view displays settings about the flows and disablements.

For more information about the program parameters, see [12.3. PROGRAM PARAMETERS on page 95.](#)

### 5.5.1.5 PROGRAM PARAMETERS - POWER SETUP

In the Aspect Tool press  and then press  :

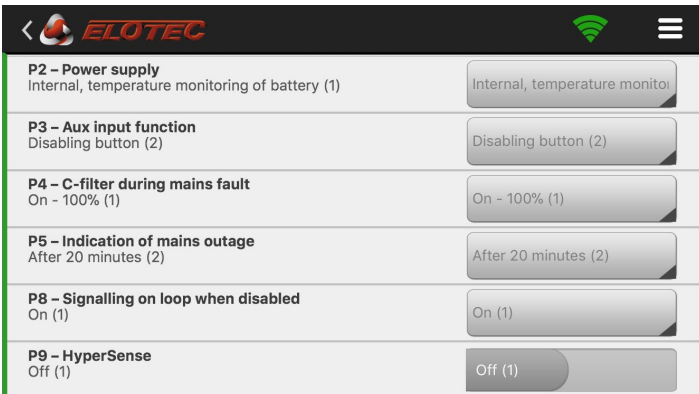

This view displays settings about the power, signaling, and sensitivity.

For more information about the program parameters, see [12.3. PROGRAM PARAMETERS on page 95.](#)

## 5.5.2. CONFIGURE ASPECT, RED ZONE

The red zone represents functions that will affect the operation of the Aspect.

Several parameters can be configured to achieve optimal function for the Aspect. Parameters that have been changed are highlighted in blue. The Mail report button generates a PDF with all the configured parameters.

See [12.3. PROGRAM PARAMETERS on page 95](#). for an overview of these functions.

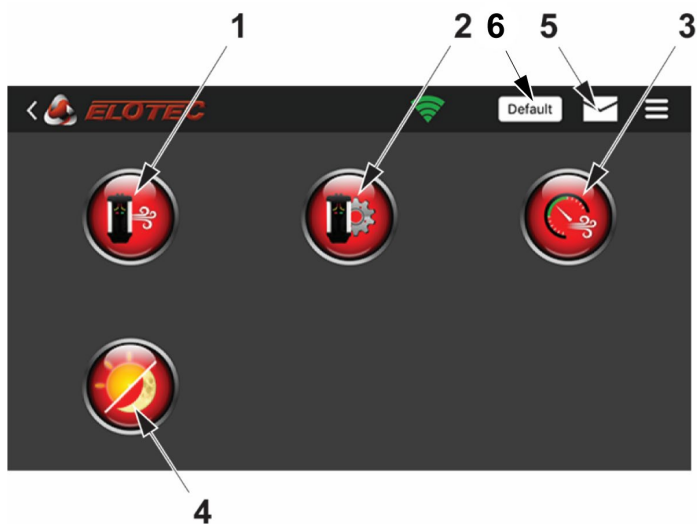

1. Configuration (air flow/disablements)
2. Configuration (power /signaling)
3. Calibration
4. Day/night mode
5. Mail report
6. Default. Will reset values to their default values for configuration of air flow/disablements (1). P6, P7, P10, P11.

### 5.5.2.1 AIR FLOW AND DISABLEMENT

In the Aspect Tool press  and then press  :

#### FAN SPEED ADJUSTMENTS

For class A and B installations, the fan speed must always be set to maximum (10).

For class C it can be reduced, in order to reduce the noise, or if the pipes are very short. The most important is that the sensitivity of each hole is within the requirements and that the response time is also within the requirements. Make a smoke test in the last hole on the pipeline and verify that the transportation time is within 120 seconds according to EN54. Or transportation time according to local regulations.

The following configurations are acceptable.

Fan speed	4	7	10
Maximum pipe length	40 m	60 m	100 m
Maximum holes per pipe	6	8	10
Minimum vacuum in last hole			
1 pipe total (using THUB)	0.75 cmH2O		
2 pipes total (1 per area)	1 cmH2O		
Noise reduction	5 dB	2.5 dB	--

*For installations with more than one pipe per area (using THUB), fan speed must always be 10.*

*PipeDraw is always calculating with fan speed 10.*

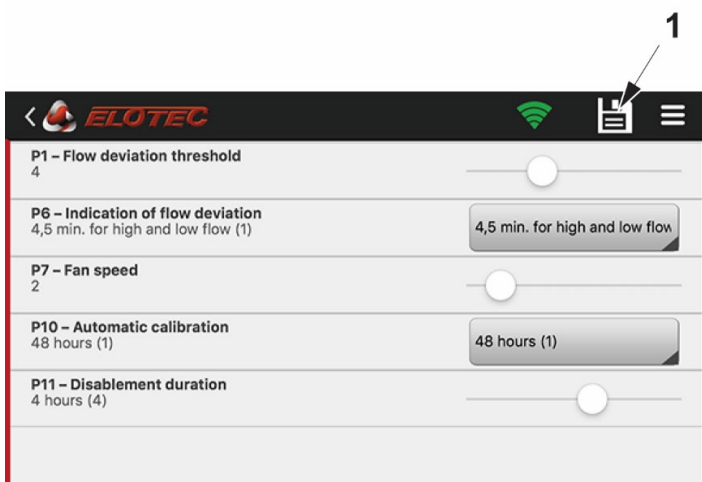

1. Diskette icon

*Fan speed changes immediately on the Aspect when you move the P7 slider. You still need to press the diskette icon (save) to make the change permanent.*

### 5.5.2.2 POWER SIGNALS AND SENSITIVITY

In the Aspect Tool press  and then press  :

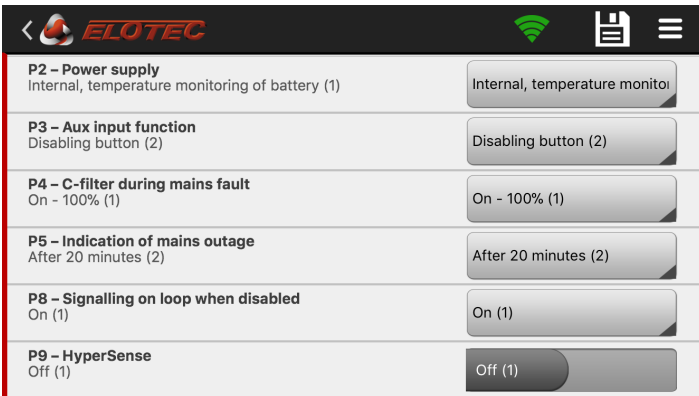

### 5.5.2.3 SENSITIVITY DAY/NIGHT MODES

In the Aspect Tool press  and then press  :

Sensitivity can be set per area, and it is possible to differentiate between night and day. Press the sensitivity indication to cycle through available options. The options will differ depending on what sensor kit is installed. Press the sun or moon icons to change the starting time of day and night respectively.

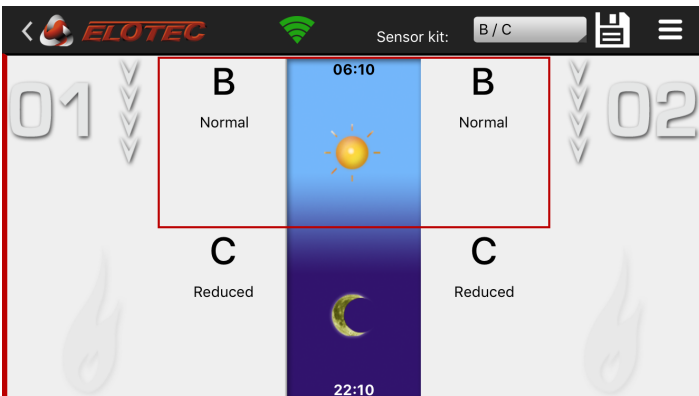

Use the dropdown in the action bar to select which sensor kit is installed in the Aspect. Available sensitivity levels will reflect this selection.

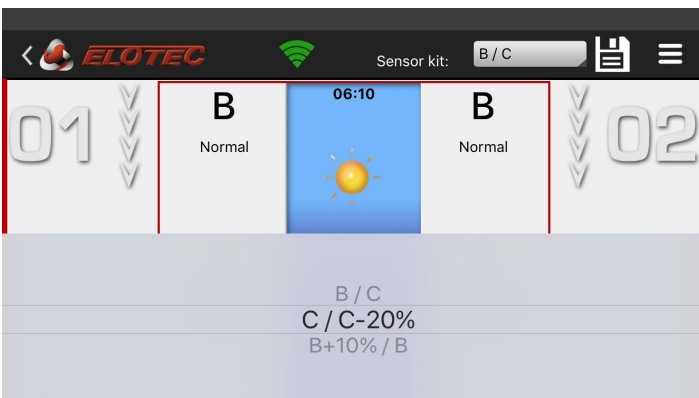

- B/C (Standard)
- C/C- (Dusty environment)
- B/B+ (Clean environment)

### 5.5.3. EDIT USER INFORMATION



Under user information, you provide contact information that is used for filling in and sending system reports. The Account ID is automatically retrieved from your phone, and is used for licensing. The fields Name, Company, and My e-mail must be filled in before you can start using the app. Press the diskette symbol to save the changes.

Field Label	Value
Account ID:	lucas.strohm@gmail.com
Name:	Lucas Strohm
Company:	Electrician Ltd.
My e-mail:	lstrom@electrician.com
Copy to:	projectmanager@electrician.com
Copy to:	

[Privacy policy](#)

## 6. ASPECT ACCESSORIES

### 6.1. ELOVAC

The manometer EloVac is an important aid for verifying that the pipeline has adequate suction.

Ensure that the instrument uses the measuring unit  $\text{cmH}_2\text{O}$ , so that values correspond to the ones read from the Aspect.

The instrument is used to measure the vacuum in the last of the pipe holes. The result from the measurement can be entered into the Aspect Tool to see if the performance of the pipeline is acceptable.



### 6.2. THUB

THUB is a mounting console that makes the installation easier. THUB is mounted on the wall and the Aspect pipes are simply clicked into place.

A built in self-emptying water reservoir takes care of the condense in low humid environments.

THUB has an extra pipe entry on the side for VULCAN. This implies that the units require less wall space.

For more information, see section [8.2.2. THUB on page 61](#).



## 6.3. VULCAN

Vulcan cyclon filters separate both dust and condensation from the sampled air before it reaches the Aspect – without affecting transport time or sensitivity.

Since the Aspect has built in filters and special designed sensors that counteracts the impact of dust, the Vulcan filter is only required in environment with an extreme amount of larger dust particles, for example wood industry, textile industry, chicken farms, paper recycling etc.



THUB with Aspect, and two Vulcan connected.



Vulcans installed back to back.

The VULCAN has been carefully designed not to increase transport time by more than five seconds.

***Vulcan must be connected to earth, to avoid static charge, which reduces the performance of the Vulcan.***

For more information, see section [8.2. MOUNTING](#) on page 59.

## 6.4. POWERHOUSE

PowerHouse is a battery cabinet, for up to four 12V lead batteries. The battery cabinet is designed for use with Aspect internal power supply (charger). The cabinet has IP44 protection class.

When using the internal charger in Aspect, the EN54-4 charging requirement is maintained when using up to 24Ah batteries. A maximum of 10 m battery cable (1.5mm<sup>2</sup>) is recommended.

The PowerHouse has an easy and secure installation using its own connection card and battery connection plugs. One fuse protects the batteries. Receptacle adapters for 6.3 mm and 4.8 mm are enclosed with the PowerHouse. Also battery cables for four batteries are included.

The batteries in PowerHouse are connected in parallel, and there is one conductor from PowerHouse to Aspect. Aspect measures the internal resistance of the batteries, and it will be almost the same as when using 1 battery. Since all the batteries are exposed to the same environment and load, the condition of the batteries will also be fairly similar.

When the batteries start to fail, Aspect will also report a battery fault.

Connect the PowerHouse according to illustration below, and remove the temperature sensor from the Aspect CPU board. The LED: s on the PowerHouse are lit when the battery is connected.

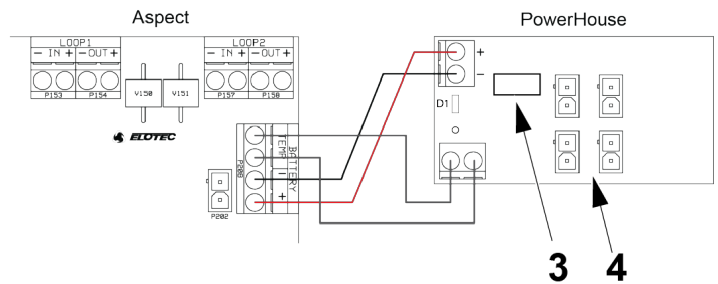
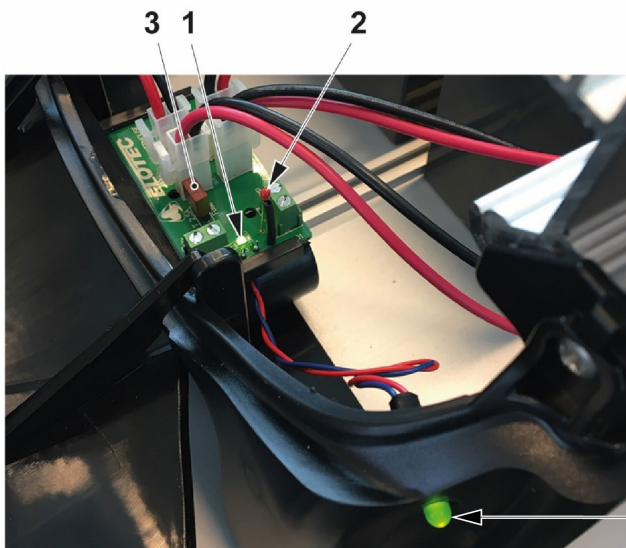

1. LED (Parallell LED:s)
2. Temperature sensor
3. Fuse for batteries:TE5 2.5AT / 250V
4. Connectors for batteries

**Batteries should be handled according to manufacturer's recommendation.**



Max battery capacity	4 X 9Ah 12v (36Ah)
IP grade	IP44
Dimensions	272 x 530 x 143mm
Nominal voltage rizzle range	12V
Max Cable length	10 m (Single core 1,5 mm <sup>2</sup> )

## 6.5. SNIFFER

The Sniffer can be used where it is desirable to conceal the pipeline (for example in churches) and/or where it is a need for protection against insects, such as in greenhouses. The combination of hidden pipelines and the nearly invisible sniffer sampling points offers a discrete system for detection both above and beneath the inner ceiling.

The Sniffer is available in two lengths: SN 253 P with 3-meter sampling point, and SN 258 M with 0.75-meter sampling point.  
Material: Pipe; Hard PVC with UV protection. Sniffer; ASA plastic with UV resistance.

For more information, see section [7.3. CHURCHES on page 52](#).

Maximum allowed number of sniffers and sampling holes in combination is 12, on a 100-meter pipeline.

When you combine sniffers and sampling holes, be sure to maintain increasing size of the drilled holes towards the end of the pipe. The drilled holes between the sniffers shall not exceed 3,5 mm in diameter.

When there is need for a drilled hole in the end cap or in the outer end of the pipe, use drill size:

- 8 mm if you have 7-8 sniffers
- 9,5 mm if you have 5-6 sniffers
- 11 mm if you have 3-4 sniffers

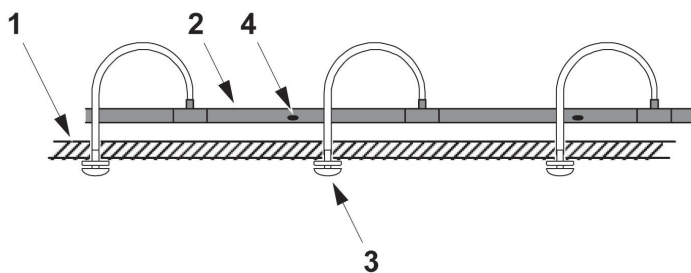

1. Ceiling
2. Sampling pipe
3. Sniffer (SN 250/SN 258M)
4. Sampling hole



SN 258 M



SN 258 P

### INSTALLING THE SNIFFER:

- a) Drill a hole with a diameter of 13 mm in the ceiling.
- b) Fit the sniffer insert in the pipeline like a regular socket. The tube should exit from the top half of the pipe.
- c) Remove the outer cover from the sniffer
- d) Pull the tube through the hole in the ceiling, and press it firmly onto the sniffer head.
- e) Guide the sniffer head into the through-hole. Fasten the head using 3 mm wood screws, and press the outer cover back in place.
- f) Fit an end cap on the pipe.

## 6.6. DIAMANT

The DIAMANT is a filter protection that provide the Aspect flow sensor with excellent protection against particles and condensation. When ordered as a spare part, it is supplied in a kit with necessary tubes for different modules of the Aspect.

Change the DIAMANT filter on annual check or when necessary. See section [9.2.4. INSPECTION AND REPLACEMENT OF DIAMANT on page 83](#).

Collected particles are clearly visible in the front of the DIAMANT.

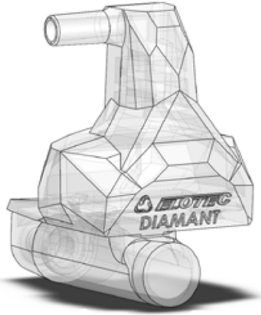

## 6.7. EXHAUST KIT

The exhaust kit, AU002 or AU003, is used for example in poultry plants where the Aspect is mounted outside the animal room. Exhaust kit AU003, with flexible hoses, is used on Aspects with THUB and VULCAN. The exhaust kit allows the Aspect to be fitted with two blowout pipes of up to 4 meters.

If the Aspect is installed in rooms with large amount of dust, always use a minimum of 0.5-meter pipe to lead the dust from the exhaust air, away from the Aspect.

If there is a large difference in pressure between the area where the air is sampled and the area where the Aspect is mounted, the exhaust pipes are used to return the exhaust air back to balance the pressure.

If the Aspect is placed in a freezer room, an exhaust kit with 50 cm pipe is necessary to lead the exhaust air, away from the Aspect. Small particles of ice in the air can be mistaken for smoke particles.

It can also be used to reduce fan noise up to 5-10 dB, or avoid the spread of odours if an office environment samples air from live-stock rooms or similar.

The exhaust kit is easily installed without tools. Just set the kit into the slot in the exhaust port, and push until it snaps into place.



*The length of the exhaust pipes must be calculated into the total pipe length. If very long exhaust pipes are required (max. 4 m) , it may be necessary to shorten the sampling pipes in order to keep the response time of the Aspect within the limits.*

## 6.8. CONDENSE BOTTLE

THUB has a built in self-emptying water reservoir to take care of condense in low humid environments.

Where high humidity and temperature differences produce large amounts of water in the pipeline, a condense bottle is used to remove condensation from the sampled air, before it enters the detection chamber.

### 6.8.1. LK 501 - CONDENSE BOTTLE WITH UV-STABILISER

LK 501 is used in special cases, where water can accumulate along the pipe line and clog the sampling holes. For example, if the pipe line follows irregularities of the ceiling.

The bottle is made of UV resistant plastic and withstands freezing. It holds 500 ml water.

To drain excess water, connect a plastic tube of up to 3 m length and an inner diameter of 7 mm, outer diameter of 10 mm.

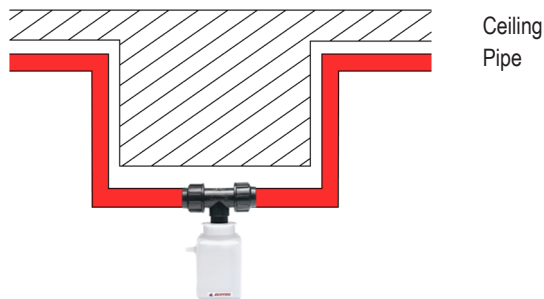

## 6.9. ELOCLEAN

EloClean is used for simple and safe cleaning of the Aspect pipelines by use of air. A powerful fan (5600Pa) is used to blow the dust out of the pipes. The cleaning process is initiated automatically between 1 to 7 times per week. For EloClean delivered after the date 20th September 2020, the cleaning interval is selectable. The process can be started manually – this will not affect the set intervals / time for automatic cleaning.

Before the pipe is blown clean, the external valve between EloClean and Aspect is closed to protect the detector, and cleaning process only proceeds if the valve is confirmed closed. EloClean will clean area 1 first, then area 2. The cleaning procedure takes approximately three minutes in total.

EloClean is intended for installations with extreme amounts of dust where one can observe dust accumulating in the pipelines or in the sampling holes, for example poultry stables, paper waste treatments

See also sections [8.2.3.1 EXTERNAL VALVES](#) on page 62 and [11.2. ELOCLEAN](#) on page 91.



Included parts for EloClean:

- 1 pc. EloClean unit
- 1 pc. THUB for Aspect, 2-6, including end caps
- 2 pc. external ball valves
- 4 pc. pipe stubs with threads
- 2 pc. extended T-joins
- 1 pc. lithium battery 9V LI-SOCL2

Included pipe parts are in grey color.

Conduits for running cables between EloClean and Aspect NOT included

ELOCLEAN CPU BOARD

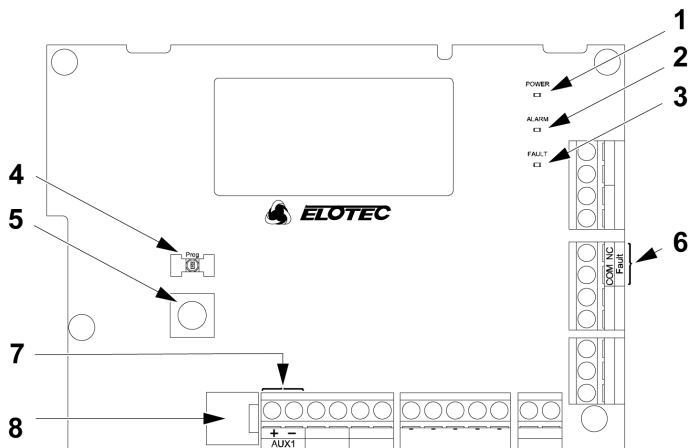

LEDs

1. Green status LED:  
Constant: Normal.  
Flashes once per second: Cleaning in progress.  
Flashes 4 times per second: Cleaning postponed due to fault.
2. Red LED: Not in use
3. Yellow fault LED (priority view)  
Constant: Jammed valve.  
Flashes once per second: Low voltage, internal battery.  
Flashes 4 times per second: Supply fault (loss of internal 12V) – auto reset on external power restore.
4. Blue status LED:  
Constant: Programming in process.

BUTTONS

5. EloClean has one simple button for operating. This button is placed on the CPU board inside the device. The button has varying functions depending on how long it is operated and the state of the EloClean.  
In the normal state:  
Short press – manual start of cleaning procedure.  
Long press (>5 seconds) – start programming. See [page 45](#).  
In the fault or alarm state:  
Short press – acknowledge event (stops the internal buzzer).

OUTPUTS

6. 1 pc. fault relay, NC, fail-to-safe.

INPUTS

7. 1 pc input for remote control of the cleaning procedure.  
This enables controlling EloClean from an external impulse switch or from a fire alarm panel through I/O.  
Short the input to initiate cleaning.

BUZZER

8. Internal buzzer: Pulsating tone in fault condition.

### PROGRAMMING THE INTERVAL FOR AUTOMATIC CLEANING

This section is valid for EloClean delivered after 20th September 2020.

To set a cleaning interval, EloClean must be put into programming mode. The interval may be set from 1–7 days.

- a) Hold button for five seconds – until the blue LED marked “Prog” lights up.  
When the LED turns on, programming must begin within 10 seconds, or EloClean will automatically return to normal operation.
- b) Press button the number of days (1–7) you wish as the interval for automatic cleaning.  
There can be no more than 2 seconds between each press. If more than 2 seconds pass between press, programming ends automatically.

When programming ends, the blue LED will blink the number of days selected, accompanied by the same number of beeps. The LED will then turn off to indicate normal operation.

### FAULT OUTPUT

A fault relay is available on the CPU board (NC).

The fault relay can be connected to the AUX input of the Aspect if no directly wired disabling button or external PSU is used. The input must be configured as a general fault input (P3=1).

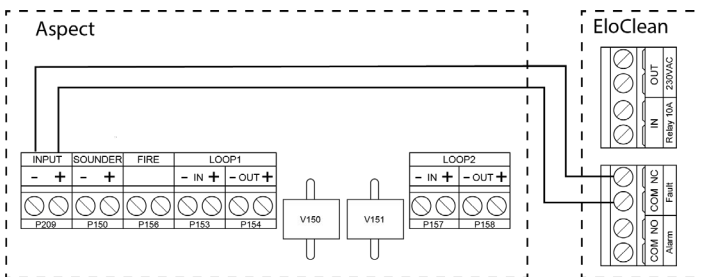

ELOCLEAN POWER SUPPLY

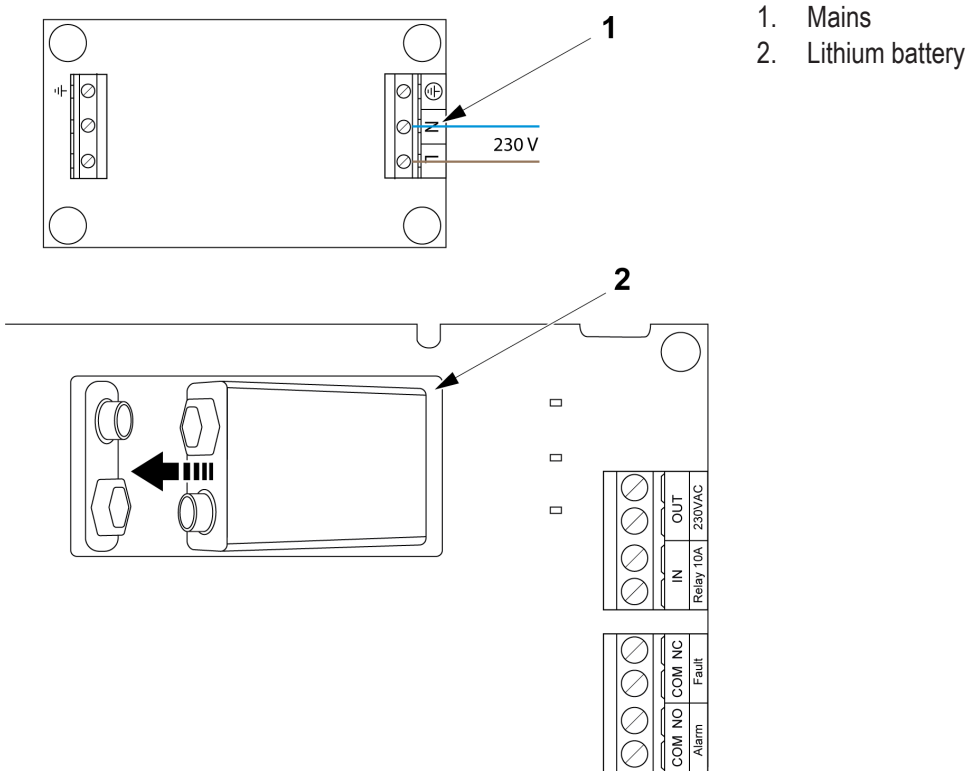

Connect the 230V mains on the right-hand side of the mains filter in the top of the device.

Connect the "9V LI-SOCL2" lithium battery to the plug and fasten it in the opening in the CPU board. The "9V LI-SOCL2" battery is a backup for the internal timer. If Eloclean have a short power loss (approx. 5 minutes), it will still perform in the correct time.

***When connecting the mains to Eloclean and Aspect, connect to a household removable fuse intended for these units only and marked according to national regulations and code of practice.***

***According to EN 60065, equipment with a permanent connection to mains (all-pole mains switch) shall have a contacts separation of at least 3 mm.***

## 6.10. PIPELINE PARTS

### SAMPLING PIPES



Original pipes are marked with the Elotec logo to assure that approved pipes are used. Marks are also applied at two meters intervals to assist in correct placement of sampling holes, as well as a guideline along the length of the pipe to help avoid twisting the pipeline.

Joins are made through special sockets or bends – no glue is needed, as the sleeves are conical and supplied with a sealing agent inside.

#### DATA

Material	PVC
Classification	(EN 61386) 3441
Internal Ra value	1.6 (max.)
Operating temperature	-45 to +60 °C
Installation temperature min.	-25 °C, preferably > 0 °C
Diameter (outer/inner)	25 / 22 mm

Plastic pipes can be used up to 60°C.

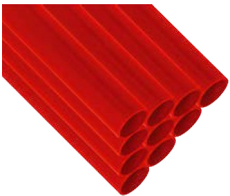

Aluminum pipes are recommended for temperatures above 60°C.

Aluminum pipes are not pre-glued. Elotec recommends Tec7 Trans-Clear as a sealant. A clear, flexible MS Polymer. Use <2g for each sleeve.



**According to VdS/EN54-20, pipe parts must comply with EN61386-1, at least class 1131. Use only approved original Elotec pipes that fulfil additional demands to rigidity (prevents drooping) and surface finish.**

## CLIPS

The entire pipe system is fixed to walls and ceilings using fastening brackets. The standard clamp CL 250 is open, and the pipes can be pushed straight in. The clamps are spacious enough to allow free movement of the pipes, which is important where large temperature variations are to be expected. Wire suspension is also an option.

Some examples of clips:



CL 253  
Red  
Standard



CL 250 W  
Grey  
For wire



CL 251 W  
Black  
For wire



CL 255  
White  
Closed, roomy

## JOINS



BE 253 90° pipe joints



BE 253-45B 45°  
pipe joints, m/f



SK 253 Straight  
socket



AL 250B 90°  
Aluminum pipe joints



AL250S Aluminum  
coupling sleeves

45° joints can be combined for adaptation to tricky areas.

## 6.11.ELOCUT2

Elotec pipes are delivered in 4 m segments that may be cut to length where needed. To ensure clean cuts with no burrs, use the ELOCUT2 cutting tool.



More accessories are found in the separate document "Accessories List" MEW01860.

## 6.12. BATTERY - BA 1800

18 Ah battery LiFePO4

LiFePO4 batteries have a substantially longer life span than that of traditional acid batteries. This reduces the need for battery replacement.



**BA 1800 is intended for use in Elotec Aspect, and it is important to set the following program parameters:**

- **P2=1 (Use temp. probe to prevent charging below 0 °C)**
- **P4=3 (Low effect condensation filter for 27 hour backup)**
- **P13= (Specify battery type for correct charging method)**

### DATA

<b>Voltage</b>	12.8 V
<b>Capacity</b>	Typically 18 Ah Minimum 17.8 Ah
<b>Lifespan</b>	Up to 10 years
<b>Terminal</b>	Molex 5557-02R
<b>Internal resistance</b>	≤ 220 mΩ
<b>Max discharge current</b>	3000 mA
<b>Operating temperature</b>	0 to +45 °C
<b>Storage humidity</b>	< 75% RH
<b>Protection</b>	Wrap
<b>Dimension (LxWxH)</b>	144 x 66 x 100 mm (± 2 mm)
<b>Cable length</b>	300 mm (± 5 mm)
<b>Weight</b>	Approx. 1.762 kg

## 7. SPECIAL APPLICATIONS

### 7.1. GREENHOUSES

In greenhouses where screen curtains are employed, it is necessary to make the system capable of detecting smoke both under and above the curtains as if they were separate rooms.

The sniffers can be used as below, mounted on extension branches. The pipes are mounted with wires.

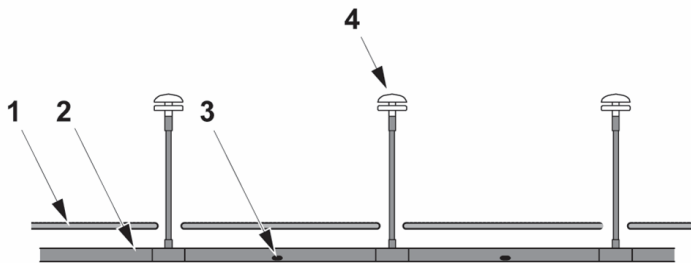

1. Screen curtain
2. Sampling pipe
3. Sampling point
4. GG 256 Gartner 0.8 m sampling point



GG256

*When the distance between curtains and ceiling are more than 2,2 meters, use pipes above and below the curtains.*

*When reaching an ambient temperature above 60°C, use aluminum pipes.*

Recommended programming in Aspect tool for green houses:

P1:10 (Flow deviation)

P10:1 (Automatic calibration)

P6:2 (6h for high flow, 30 min. for low flow)

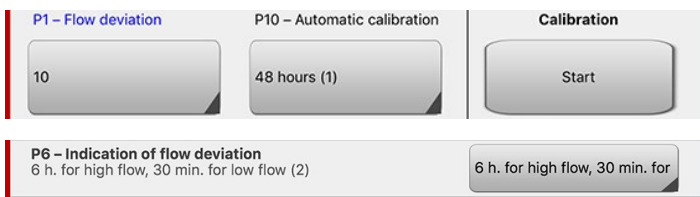

## 7.2. POULTRY AND PIG FARMS

Because of the large amounts of dust usually associated with poultry and pigs, the Vulcan dust- and condensation filter should always be installed when using Aspect in poultry houses or pig stables.



It is recommended to place the Aspect in a room adjacent to the detection area.

Ventilation systems in such stables usually generates a large negative pressure. Therefore, the exhaust kit must be mounted, with pipes leading the air back into the detection area. This equalizes the pressure difference, which would otherwise affect the airflow.

In cases where the Aspect must be placed inside the detection area, the exhaust kit, AU002, must be mounted, with short pipes attached (0,5 m). This is to avoid dust from being sucked into the Aspect by turbulence.

Both detection areas must draw air from rooms with approximately the same pressure level.

## 7.3. CHURCHES

Aspect is an early warning system which is very suitable for securing churches, and with the use of sniffers, the system is also very discreet.

The pipelines are placed in the church loft and the sniffers are installed so that the sampling point is drawn through the roof and into the church. Only the cast sniffer head will be visible inside the church. Sniffer tubing of type SN 258 M is flexible and steel coated, for protection against mice and similar rodent holes in inaccessible places.

Sniffers may also be placed in the eaves to provide outside detection.

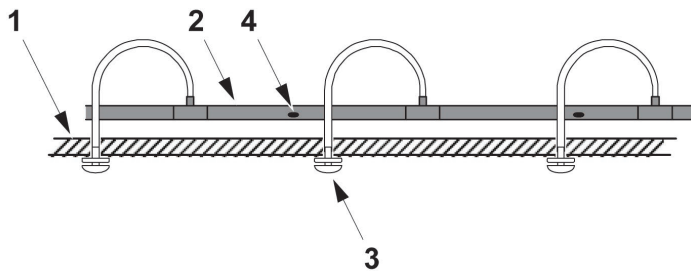

1. Ceiling
2. Sampling pipe
3. Sniffer (SN 250/SN 258M)
4. Sampling hole

*When laid sampling points (branches or sniffers) are used, the end of the pipeline must always be closed.*

KG Cross (KG 252/KG 253) can be used to split the pipeline and achieve more effective coverage of the church. All branches must have the same air pressure and sample air from the same room.

## 7.4. COLD STORAGE

Aspect has properties that make it suitable in rooms with temperatures down to -30 °C.

In cold storage is recommended Aspect Grizzle with Class C sensors (AE2010GN-P). This sensor with less sensitivity is used, because there is a risk that humid air freezes to ice particles, which can be mistaken for smoke. In addition, one should be aware of the following points:

### SETTINGS

- Condensation filter should be active even at power failure (P4 = 1). Default.
- The fan must run normally in case of mains fault (P8 = 3) and during freeze / defrost. Default.

### PIPELINES

- Pipes must be installed by 15-25 cm distance from the ceiling, using spacers or wire hanger.
- The hole diameter must be at least 3 mm to prevent clogging.
- Aspect should be placed in the same room as the pipelines, and an exhaust kit with at least 50 cm pipe is necessary to lead the exhaust air away from the Aspect.

### BATTERIES

- Note that the batteries internal resistance will increase in low temperature and thus lower capacity. It's recommended to always mount batteries outside the cold storage.
- Contact the supplier when additional capacity or assistance to calculations are needed.

## 7.5. DUSTY ENVIRONMENTS

Aspect provides early and reliable detection even in dusty environments. The Aspect has different filters that protects the sensor from the dust particles:

- In environments with large dust particles (wood industry, textile industry, recycling plants), use the standard filter (FI 003 KP) and Vulcan.
- In environments with small dust particles (concrete industry, welding operations, etc), use the white filters (FI 004KP) and no Vulcan.

In some cases, the fan speed can be reduced, and then the filters can be changed less frequent. Perform a smoke test, and verify that the air transportation time is within 120 seconds.

The hole diameter of the sampling holes must be at least 3 mm to prevent clogging.

EloClean can be used in installations with extreme amounts of dust for cleaning of the Aspect pipelines. During the cleaning process a powerful fan blows the dust out of the pipes.

Also make sure to use the exhaust kit (AU003 or AU002) and at least 50 centimetres of pipes connect to the exhaust kit to reduce dust particles around the detector.

## 8. INSTALLATION

### 8.1. PLANNING

#### 8.1.1. CABLE

Cables should be selected according to the requirements of the system in which the Aspect will be used. The necessary dimensions of the cable will depend on the number and type of units connected to the loop, and the total length of the loop. Likewise, cable dimensions may limit the permitted length of the loop, or the number of connectable devices.

National or local requirements may specify minimum requirements for alarm system cable.

#### 8.1.2. PIPES

Sampling pipe layout should be designed to sample air from all the protected area, while keeping the transport time within the specified limits. EN54-20 sets the transport time limit to 120 seconds. The number of pipes that may be connected to the Aspect depends on the required sensitivity class.

Determine obstacles that may require special attention / routing (walls, beams, ventilation, etc.).

*100 m of pipe enables the covering of large areas, but is not suited for detection in many small rooms. If a pipe is run through too many rooms, identifying the exact location of the fire will take too long.*

Temperature, air pressure, and humidity need to be taken into consideration when deciding the placement of the Aspect and the path of the sampling pipes. The Aspect should not be placed in cold rooms, unless the sampled air also comes from a cold room.

As warm air is sucked into a cold room, condensation will form. If the temperature of the room is below freezing, this condensed water could freeze inside the pipe and clog it. For this reason, pipes should always run from cold rooms to warm rooms whenever possible.

The pipes shall always be allowed to run 2 meter inside the room where the Aspect is mounted before entering the detector. In this distance the air temperature in the pipes will adjust, and condensation is avoided.

Make sure there is enough space on each side of the Aspect for installation of any required filters, condensation bottles, or Elo-Clean.

### 8.1.3. PIPEDRAW

PipeDraw is a program that makes the pipe calculation easy.

The program can be used to:

- verify area coverage for documentation
- hole calculation and pipe layout for installer
- generate a shopping list for purchaser
- verification of rules and guidelines for authorities (sensitivity, transportation time and so on)

*PipeDraw always calculates the projects with fan speed 10.*

Import a drawing of the site and set the scale of the drawing. The program supports pdf, dwg, and dxf. Set ratio.

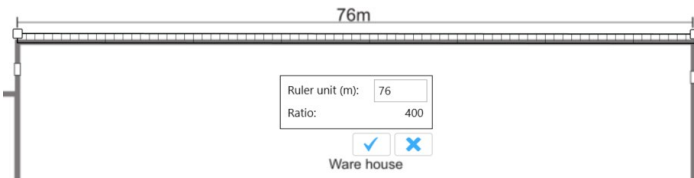

Use the list to the left to place your Aspect and draw the sampling pipe layout.

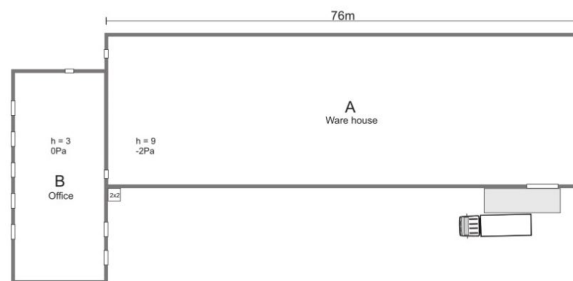
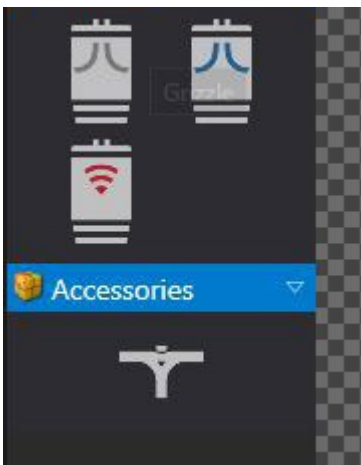

It is possible to show the area of coverage per sampling hole.

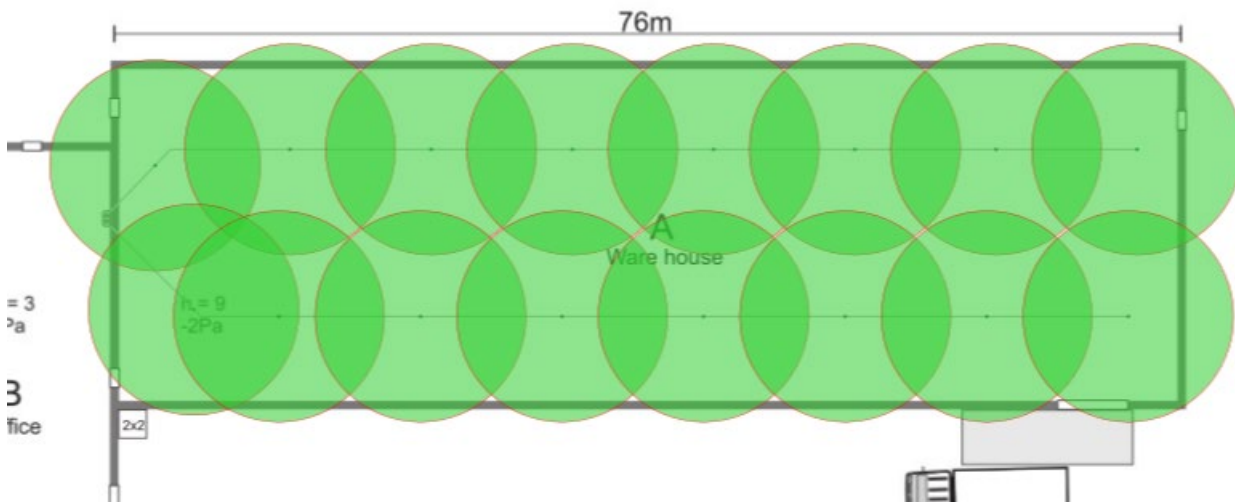

A shopping list, an excel file, can be generated when you are finished with the layout.

	A	B	C	D	E	F
1	Summary					
2	<b>No</b>	<b>Article number</b>	<b>Description</b>	<b>Unit</b>	<b>Quantity</b>	<b>Note</b>
3	1	AE2010G	Grizzle	Pcs	1	
4	2	PL252	Pipe	Pcs	42	165.9 m
5	3	SK252	Straight Connector	Pcs	36	
6	4	BE 253-45B	45 Degree Connector	Pcs	2	
7	5	BE 252	90 Degree Connector	Pcs	2	
8	6	EP250	End Cap	Pcs	2	
9	7	CL 250	Pipe clip	Pcs	2	166
10						
11	KG Knutsson kolonial31 - Grizzle - Aspect 1					
12	<b>No</b>	<b>Description</b>	<b>Unit</b>	<b>Quantity</b>	<b>Note</b>	
13	1	Pipe	Pcs	42	165.9 m	
14	2	Straight Connector	Pcs	36		
15	3	45 Degree Connector	Pcs	2		
16	4	90 Degree Connector	Pcs	2		
17	5	End Cap	Pcs	2		
18	6	Pipe clip	Pcs	2	166	
19						

For more information about PipeDraw, see "Quick Guide, PipeDraw" or PipeDraw video.

### 8.1.4. PIPE LAYOUT

For most installations, it's possible to use the tables below to know how to distribute the sampling holes. Total hole area is the calculated area of all the holes, added together. Tables may be used as is, or the area can be distributed with equal hole diameters. Increasing hole diameters further out on the pipe, will maintain the same vacuum in each hole along the hole pipe.

- Class A: 1 x 100 m, indicated as one area.
- Class B: 2 x 100 m, indicated as two areas.
- Class C: 4 x 100 m, indicated as two areas.

The maximum length of a pipe is 100 m, but it can be extended by 20% if the vacuum is maintained. For class C, two identical 100 m pipes may be connected to each area.

The following table applies to 100 m pipe with a plugged end. For class A, only the green fields can be used. Yellow field is used in standard cases, approx. 100 m pipe.

		Total hole area [mm²]						
		80	88	93	96	99	119	120
Hole no.	Distance from Aspect [m]	Diameter [mm]	Diameter [mm]	Diameter [mm]	Diameter [mm]	Diameter [mm]	Diameter [mm]	Diameter [mm]
1	10	2	2	2	2	2	3	2
2	20	2	2	2	1,5	2	3	2
3	30	2	2	2	1,5	2	3	2
4	40	2	2	2	2	2	3	2
5	50	2	2	2	2	2	3	3
6	60	2	3	3	2,5	2	3	3
7	70	2	3	3	3	4	4	3
8	80	3	3	3	4	5	4	5
9	90	4	4	6	5	5	4	6
10	100	7	7	6	7	6	7	7

If the pipe is shorter than 100 meters, and must have less than ten holes, use the lower part of the pipe drilling table. Skip the top holes.

Example:

An 80-meter pipe with 8 holes; drill the first hole 10 meters from Aspect.

80
Diameter [mm]
X
X
2
2
2
2
2
3
4
7

Please note that the use of bends has no influence on the transport times and pipe lengths calculation. If the pipe length is decreased by 50%, the total hole area may be doubled. The pipe cannot be shorter than 10 m.

Where the pipes of area 1 and 2 are of different lengths, they should be balanced so that the difference in pressure is no more than 10 Pa. Please use pipe draw.

For other lengths of pipe, contact Panasonic.

ASPECT 2010 automatically adjusts for use with open-ended and closed-end pipelines. Plugged ends are preferred in compliance with EN54-20, but open ends are recommended where a shorter response time is required.

Air samples are transported to the detection chamber in the Aspect through pipes. Aspect systems use pipes with an outer diameter of 25 mm and an inner diameter of 22 mm.

Original pipes are marked with the Elotec logo to assure that approved pipes are used. Marks are also applied at two-meter intervals to assist in correct placement of sampling holes, as well as a guide line along the length of the pipe, to help avoid twisting the pipeline.

Original pipes are delivered in 4-meter segments that may be cut anywhere if needed. To ensure clean cuts with no burrs, use ELOCUT2.

Pipes must comply with EN 61386-1, at least class 1131, as well as demands to internal surface smoothness (Ra-value) and rigidity (E-module).

System performance including hole and pipe calculations are only valid with use of original pipes and accessories.

## 8.2. MOUNTING

Drill holes through the walls where required.

*When threading pipes through the walls, plug the end of the pipe using EP 250 end plugs to prevent insulation and other objects from entering the pipe.*

Fix the brackets to the walls and ceilings along the path of the pipe. The distance between the fixing points should not exceed 2 m, provided that Elotec pipes are used, and the pipe should be fixed so that the joints are stable.

In environments with severe temperature fluctuations (for example near the outer roof in barns or warehouses, or in greenhouses), the pipes may shrink and expand. Therefore, use fastening brackets that allows the pipes to move, for example pipe clips for wire suspension (CL 250W, CL 251 W). PipeDraw will always calculate with one clip for each meter pipe.

In warm environments, glue the fastening bracket on the middle of the pipe, allowing the pipe to move in both directions from the center.

*Glue one fastening bracket halfway out on long pipelines to make the installation easier.*

Set the pipe segments firmly into the brackets, and connect them with sockets and bends. No glue is necessary – Elotec bends and sleeves contain a pre-applied sealing agent. If wire suspension is used, hang the wire first.

Use only silk covered wire, which will not corrode, and provide less friction for the clamps. Place clamps on the pipe, and slide these onto the wire from one end. Adjust each joint to avoid twisting, so that the holes are correctly placed along the pipeline.

*Make sure that the pipe joints are pushed together tightly when the pipeline is assembled. It is also important to push the pipe ends well into the couplers. If this is not done thoroughly, the "false air" sucked in through the joints, which will impair the performance of the system considerably.*

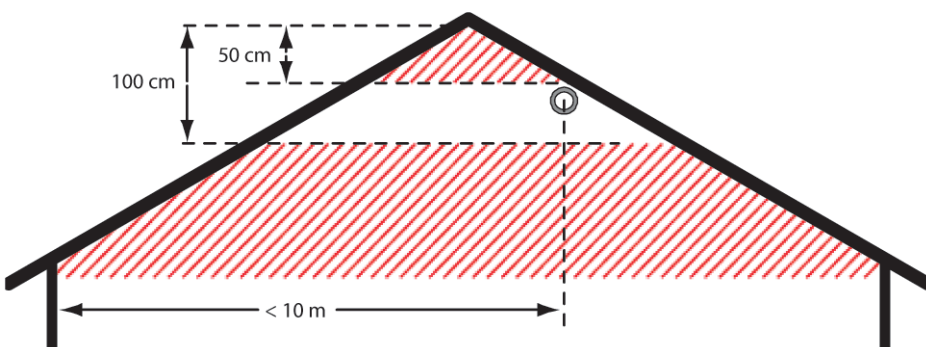

Installation of pipeline under a gable roof. Proper distance from the ridge is important.

## 8.2.1. DRILLING SAMPLING HOLES

Drill sampling holes in the pipes as specified in the planning stage. The holes are to be drilled in the lower part of the pipe. It is recommended to place them a little off-center (5 or 7 o'clock), rather than directly underneath, to reduce the risk of foreign objects in the pipe blocking the holes.

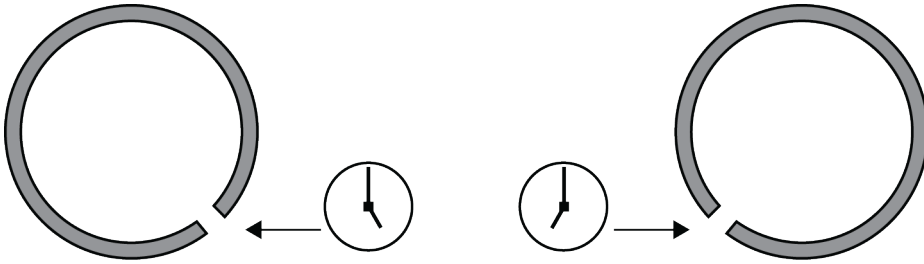

*Make sure that the diameter of each hole is as stated on the drawings. Clean the holes after drilling – ensure that no shavings remain in the pipe and that no burrs are formed on the inside that might cause dust to accumulate.*

After drilling, each hole should be marked using special labels. These assist in locating the holes during subsequent testing or service. The labels should be placed so that they point in the direction towards the Aspect, and indicates the air flow direction.



Correct marking with ASPECT to the right.

*The pipes are printed with the ELOTEC logotype and a drilling line. The distance between each O in the ELOTEC logotype is 2 meters.*

## 8.2.2. THUB

THUB is easily mounted on the wall with the built-in spirit level, and the pipes for the Aspect is clicked into place. Via the THUB, you can connect up to 4 x 100 meters of pipes, on one Aspect.

The left-hand pipe entry of the THUB, is assigned area 1; the right-hand pipe entry is assigned area 2. Please note that area 1 and 2 refers to the indications on the front of the Aspect. The fire alarm panel may assign these areas to different zones.

The THUB has inputs for three pipes per area, but only two must be used at the same time. In addition, it has integrated condensate water tank and drain hose outlet.

Snap the Aspect into the THUB. As the Aspect is relatively heavy, it is important to fasten THUB securely to the wall.

If the Aspect is mounted with a THUB, the condensations bottles (LK 501) are only needed in humid environments. THUB has a small built-in condensation reservoir that are automatically emptied by evaporation from the heat dissipation from the detector.



More information on THUB in section [6.2. THUB on page 37](#).

### 8.2.3. ELOCLEAN

For use with both pipelines on aspect, it is recommended to install EloClean directly underneath the Aspect as shown in the picture below. If VULCAN is used in the installation, external valves and pipes from EloClean shall be moved to the outside of the VULCAN.



For use with only one pipeline, EloClean can be installed right next to aspect, by using the pipe entry on the side of the THUB.

#### 8.2.3.1 EXTERNAL VALVES

External valve must be installed between the Aspect and EloClean in order to protect the Aspect – the air pressure from EloClean may damage sensitive components in the Aspect if the pipe entry is not closed. EloClean will not start cleaning until the valve is confirmed closed.

The external valves are connected to terminals inside EloClean. There are four leads per valve / area. Terminals are labelled according to area, and coloured leads shall be matched against colours on the terminal block. Sequence from left to right is red, black, green, white – first area 1, then area 2.

For EloClean delivered before September 2022, the colors of the terminal block are from left to right; yellow, blue, red, black.

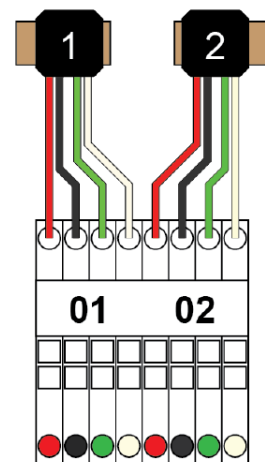

***Even if EloClean is used for cleaning of only one pipeline, both valves must be connected.***

## 8.2.4. PIPE ENTRY

*Make sure that the pipes are fed into the correct entries as described by the authorized planner, to avoid confusion regarding the area of detection in an alarm situation.*

When entering the Aspect, the pipes should not drop straight from the ceiling unless the environment is known to have low humidity (like office buildings). Lead the pipes down slightly away from Aspect, to yield room for condensation bottles or Vulcan just before entry.

### 8.2.4.1 VULCAN INTO THUB

THUB has an extra piping in the side, adapted to Vulcan. Vulcan filters shall be used in environments with larger dust particles (typically wood or textile industry), and are connected directly to the THUB.

It is important that the arrows above the text "To Aspect" point in the correct direction. If they do not, release the inner part from the cover by loosening the two snaps, and rotate it to the correct orientation.

The inner part must be connected to ground using the affixed earth cable to avoid static build-up caused by the rotation of air and dust particles inside the cyclone.

When you connect the pipe, use the two supplied sleeves.

*The special conductive material of the inner part is brittle. Be very careful when handling the inner part and connecting the pipes, so you do not break the pipe connectors.*

It is important to regularly inspect the bottles for dust and condensation water. This also applies to the filter inside the Aspect.

Be especially attentive to conditions that may affect the function of the entire installation, such as:

- Ventilation and pressure variations in different rooms.
- Water mist and humidification nozzles in the area around the holes in the pipe (alternatively make a loop around the area or move the pipeline).
- To achieve optimal effect of Vulcan, the air velocity must be at least 2.5 m/sec into the Vulcan. When the AE2010 pipeline is planned using PipeDraw, the velocity is normally adequate.

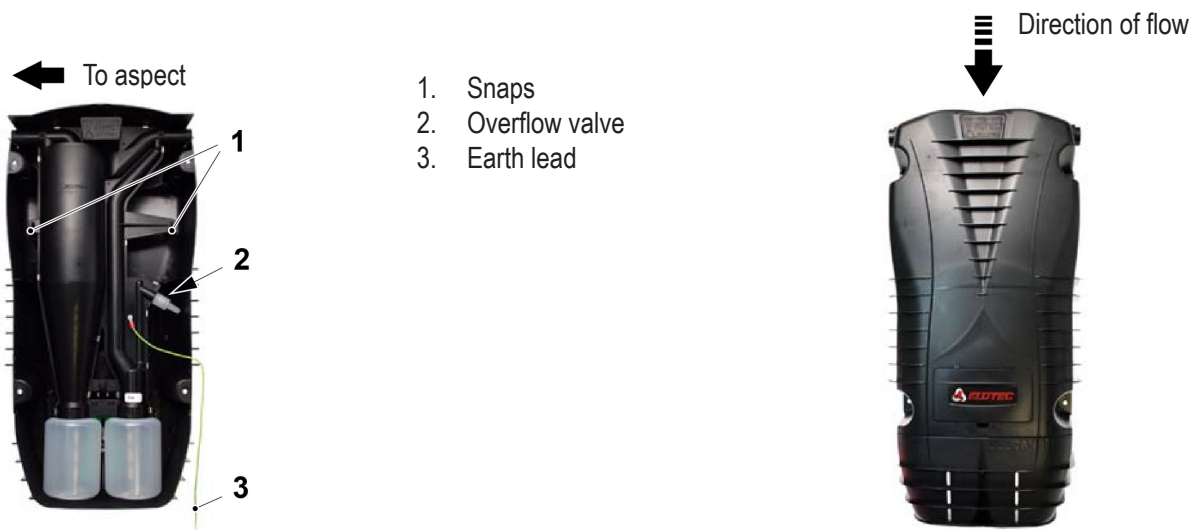

If an exhaust kit is needed in this type of installation (THUB + Vulcan), use AU 003 with flexible pipes. There will not be room for standard pipes.

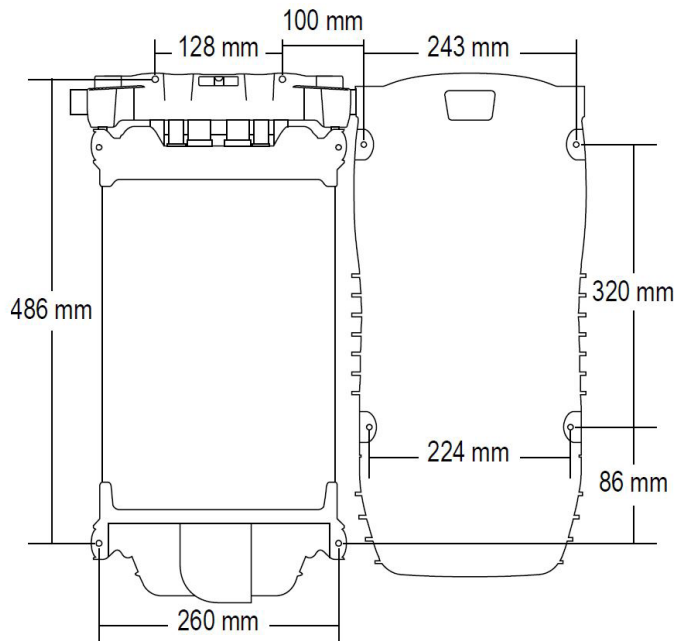

### 8.2.4.2 VULCAN INTO ASPECT

Aspect and Vulcan, mounted with the smallest distance possible using standard pipes. Aspect and Vulcan must be flush, and there should be room for pipes with standard 90° bend.

In humid environments, at least one condensation bottle shall be mounted on each pipe. The condensation bottle should always be mounted immediately before pipe entry into the Aspect.

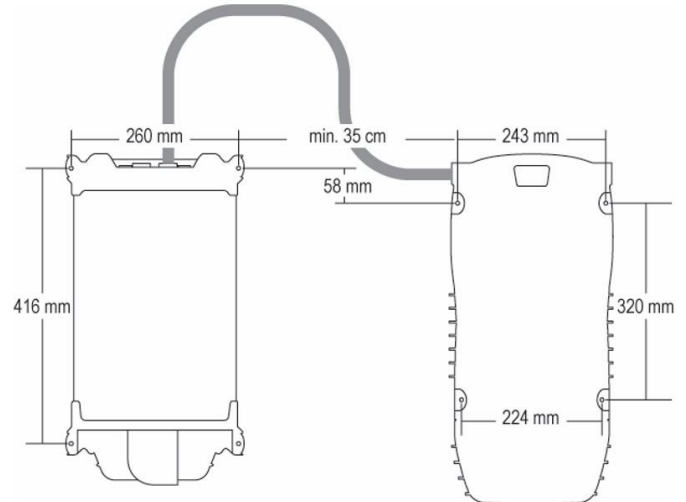

Aspect mounted with condensation bottle and Vulcan.

## 8.3. ASPECT

The location of the Aspect should have been determined during the planning phase. Mount the Aspect in place while ensuring there is enough space around the unit. If VULCAN dust- and condensation filters are used, there needs to be enough room on each side of the Aspect to mount the filter. See [6.3. VULCAN on page 38](#).

The recommended mounting height puts the lower edge of the Aspect approximately 1.5 m above the floor. There should also be enough room above the Aspect to accommodate proper entry for the pipes.

*Pay attention to temperature differences with reference to mounting height in particularly hot surroundings. The device and electronics can stand 55 °C, while lead-acid batteries should not be charged at above 50 °C. Consider self-heating and potential solar heating.*

### 8.3.1. OPENING THE ASPECT

To access the inside of the Aspect, do as follows:

1. Open the bottom cover by grasping the recesses in its upper edge, pulling forward and down.
2. “Keys” for opening the top cover are kept inside the bottom cover.
3. Insert both “keys” as shown in picture 3 and push them towards the housing to lever the top lid open.
4. Pull the top lid out and raise it; the door can now be opened for full access.

1



2



3



4



### 8.3.2. MAINS CONNECTION

Mains and earth connection are connected to the terminals marked 230V AC on the CPU board, see Appendix. The ends of the cable inside the Aspect should be approximately 20 cm long. The mains and earth cords shall be strapped together close to the terminal block.

*The mains cable should be fed through the cable entry on the left side.*

#### ALTERNATIVE MAINS CONNECTION

All Aspects can however be powered by an external 230V DC, 24V DC, or 12V DC supply.

In Aspect tool, P2 – Power Supply; Select (2) for 12V or (4).for 24V.

Parameter P3 shall be set to (1) Standard, to supervise external supply. Activation of the AUX input will be reported as power supply fault.

Connect the external power supply (i.e. 4466) with it’s own battery backup, to terminals marked BATTERY + - on the Aspect CPU board. Position 10) on “Aspet CPU board”.

The fault relay for the externa power supply shall be connected to the AUX input for supervision.

When you make this alternative configuration, you do not need to connect 230V.

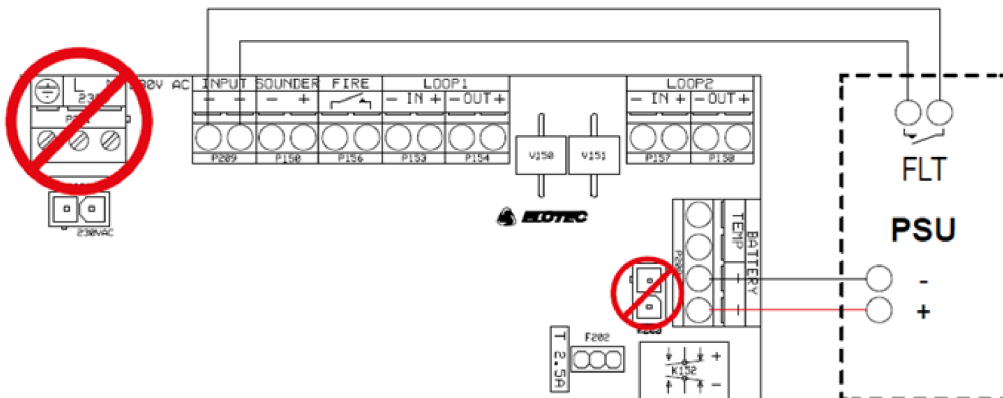

### 8.3.3. BATTERY CONNECTION

Connect the battery by plugging the battery leads into the socket on the CPU board, see Appendix.

The internal charger is dimensioned for charging up to 24 Ah batteries according to EN54-4, installed in a separate enclosure, see [6.4. POWERHOUSE](#) on page 39.

To ensure proper temperature-compensated charging, a temperature sensor must be placed onto the surface of the battery as shown in the drawing.

### 8.3.4. BACKUP BATTERY

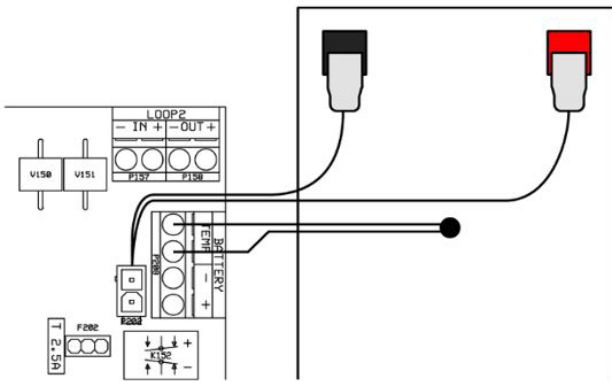

*Take proper care of the battery. Lead batteries can be damaged by deep discharge, so if a long-lasting power outage drains the battery completely, it may have to be replaced. If the battery is disconnected for some reason, self-discharge will permanently reduce its capacity if it is not recharged within 6-9 months. Standard batteries have an expected lifetime of no more than five years, and must be replaced every 3-5 years.*

*Beware of Electrostatic Discharge while working with the CPU board.*

The current drawn from the battery during mains failure will fluctuate in cycles due to the regulation of the internal condensation filter.

When attempting to measure the battery current, one must use a meter with averaging functions in order to achieve a usable result. In the tables below, you will find information on duty cycles, currents, and required battery capacity, based on type of PSU, condensation filter settings and desired backup durations.

PSU	Integrated			External	
Voltage	--	--	--	24V	12V
C-filter, setting in Aspect tool	Full (P4=1)	Half (P4=3)	Off (P4=2)	--	--
Cycle ON/OFF	260/140 ms	120 / 180 ms	--	20 / 40 ms	60 / 40 ms
Peak current	1.65-1.7A	1.65-1.7A	0.52-0.53A	1.44A	1.52A
Min. current	0.52-0.53A	0.52-0.53A	0.52-0.53A	1.22A	1.12A
Avg. current	1.30A	0.89A	0.53A	1.33A	1.32A

### 8.3.5. BATTERY BACKUP TIME

- Up to 8 Ah – Aspect can be supplied with one internal 12V battery.
- Up to 18Ah – Aspect can be supplied with one internal 12V LiFePO4 battery
- Up to 24 Ah – Aspect can be supplied with up to four 12V lead batteries in PowerHouse cabinet.
- Up to 42 Ah – Aspect can be supplied with 24V power supply 3366/4466 and maximum 2x 12V (42 Ah) external batteries in a 5014 cabinet.

C-filter, setting in Aspect tool	Full (P4=1)	Half (P4=3)	Off (P4=2)
Required backup time			
6h backup	7.8 Ah	4.0 Ah	3.2 Ah
12h backup	15.6 Ah	8.1 Ah	6.4 Ah
24h backup	31.2 Ah	16.1 Ah	12.8 Ah
27h backup	35.1 Ah	18.1 Ah	14.3 Ah
30h backup	39 Ah	20.1 Ah	15.9 Ah
72h backup	-	-	38.2 Ah

## SETTINGS

The setting for the condensation filter (P4) affects the duty cycle of the filter element during battery operation, and thereby the average current. It is the main variable for expected backup duration.

In Aspect tool:

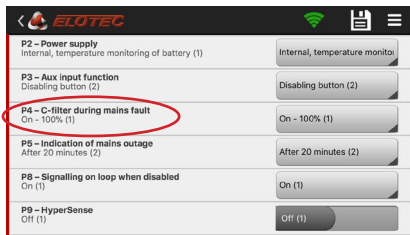
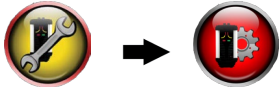

In Aspect tool B:

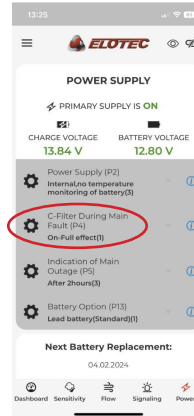

PowerHouse



Cabinet for batteries 5014

## 8.4. CONFIGURATION

The Aspect needs to be added into the configuration, for more information, see the Planning Instructions for the system.

*Aspect cannot be configured and used in an EBL512 G3 United Version.*

### 8.4.1. EBLWIN FOR EBL512 G3 and EBLOne

#### 8.4.1.1 GRIZZLE

In EBLWin, right click on a loop / Add loop unit / AE2010 N/G-P Aspect Nitro Grizzle...

Since Grizzle has two sensors, there are two separate tabs to configure.

In order to be able to disable, via the red button on the Aspect front, edit the "Disable time" field.

By default, the disable time is 0.

AE2010 N/G-P Aspect Nitro/Grizzle

General Information

Technical address 1 Name AE2010 N/G-P Aspect Nitro/Grizzle

Alarm point 01 Alarm point 02

Alarm point

Zone	Address	Alert annunciation time channel
1	1	Always off

Delayed

Disable time channel: Always off

2-unit Dependent Time channel: Always off

Text

Aspect Specific Information

Disable time 0 hours (0 = no disablement)

OK Cancel Apply Add...

### 8.4.1.2 GRIZZLE WITH ONE PIPE

If the Aspect Grizzle is used with a HUB and only one pipe, it shall be configured as a Lazeer. In the Lazeer properties window, set “Detection type” to Or:

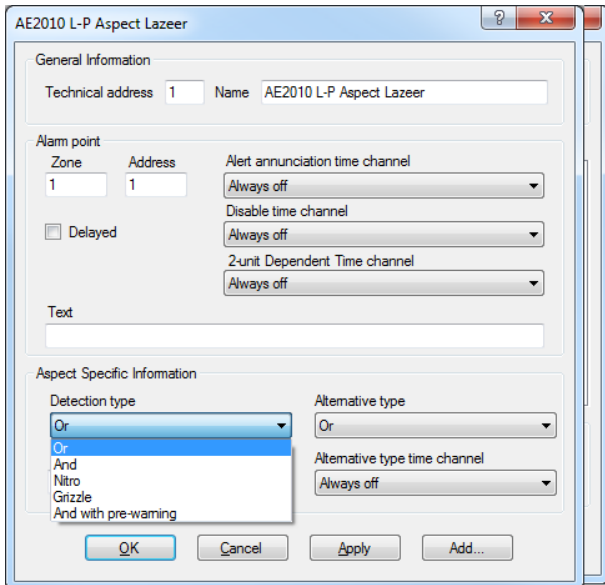

### 8.4.1.3 STAND-ALONE

A: Alarm: Input0: Zone line input, Zone (zzz, aa)

B: Reset: Output0: ResetPulseZoneAddress (zzz, aa)

C: Fault: Input2: ExternalFault, NC, "General fault in Aspect x".

**A**

**B**

**C**

## 8.4.2. WIN512 FOR EBL512

See also section 8.5.1. SET THE MODE on page 75.

### 8.4.2.1 GRIZZLE

- a) In Win512, right click on a loop / Add loop unit / Discontinued units / ADB Base (2330).
- b) In External, select External Line.
- c) Press Apply.
- d) In Text, add a customized text.
- e) Since Grizzle has two sensors, there are two separate tabs to configure.
- f) Press OK.

ADB

Internal Addressable Base | External Addressable Base

General information

Tech. no. 000001 Logical Name ADB

Zone 1

Address 1

Specific information

Always alert annunciation Alert annunciation time channel 0

Always two unit dependent Two unit dependent time channel 0

Delayed alarm Disable time channel 0

Text External External Line

Aspect Grizzle

External LED

External Line

External line with same address

OK Cancel Apply Help

## 8.5. SET THE COM LOOP ADDRESS

Each COM loop unit must have a unique COM loop address (001-253). Address range may differ based on the SW version used, see planning instructions for more information. Set the address with the Address Setting Tool (4414E). Use the connection cable with crocodile clips to connect to the flying leads placed in the detector's "LOOP 1 IN".

*The COM loop address and mode settings must be done before the unit is connected to the COM loop.*

### 8.5.1. SET THE MODE

Set the mode with the Address Setting Tool (4414E) according to the table below.

	Advanced mode	NORMAL mode	2330 mode	2312 mode
EBL512 G3	Not used	$V \geq 2.1$	Not used	Not used
EBLOne	Not used	$V \geq 3.2$	Not used	Not used
EBL128	Not used	$V \geq 2.1$	Not used	Not used

*The software version of the Aspect interface board 4586 is found on the backside of the board. See also section [12.2. ADDITIONAL CIRCUIT BOARDS](#) on page 94.*



## 8.6. WIRING

### 8.6.1. GRIZZLE

Only the LOOP 1 IN terminals are used to connect the Aspect to the CIE. Remaining loop connection terminals should not be used. The loop should be connected first. Then the mains cable.

All necessary cables enter the Aspect through glands on top of the unit. The mains cable should be fed through the cable entry on the far left, and loop cables on the right to get the easiest access to the terminals. The ends of the cable inside Aspect should be approximately 20 cm long.

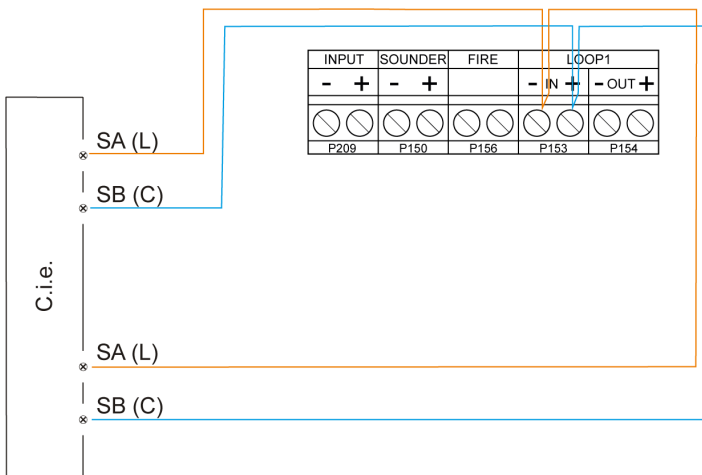

**Remember to seal the cable entries properly when all cabling is complete, and all connections have been made.**

## 8.6.2. STAND-ALONE

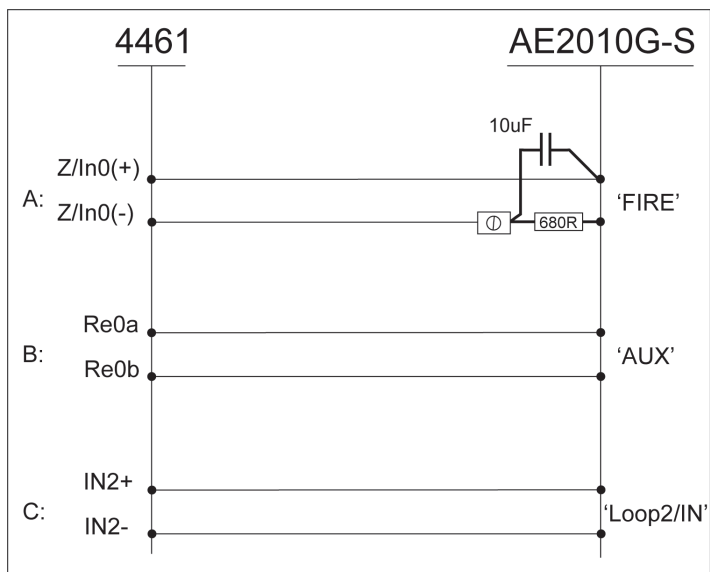

An alarm resistor is required for the stand-alone Aspect to fulfil EN54-13.

A: Alarm

B: Reset

C: Fault

*Regarding C; the wire is supervised for open circuit only.*

See EBLWin configuration in [8.4.1.3 STAND-ALONE](#) on page 73.

## 8.7. CALIBRATION

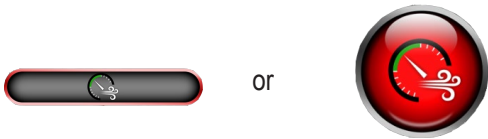

After all connections have been made, the Aspect must be calibrated to the correct air flow. Tolerance to and warning of changes in the air flow must be adapted to the building mass and usage. To be able to calibrate, the fan in the Aspect must be running, and the flow value must be above 1,6.

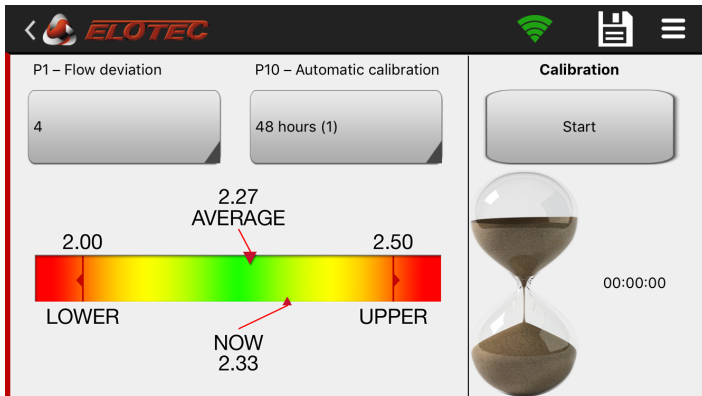

Log on to the Aspect with the Aspect tool - make the hand shake (green sleeves). Press the button below the Calibration header to start the process. The initial calibration will take about one minute, and the remaining calibration time is displayed to the right of the hourglass. After calibration, arrows should be in the green area.

LOWER / UPPER are the limits set in P1 for flow deviation tolerance. The time it takes to receive the indication of flow fault is set in program parameter P6.

Shortcuts for changing program parameters P1 and P10 are available – press the diskette symbol to save the changes.

### P10

P10 has different choices of auto calibration during start-up.

- (1) Aspect uses 48 hours to calculate / stabilize the flow window.
- (2) Aspect uses 7 days to calculate / stabilize the flow window.
- (3) Aspect uses longer time to calculate / stabilize the flow window. It is also based on the different seasons during the year, adapted for green houses.

***P10 is only active when P1=1, all other settings of P1 makes P10 inactive.***

***Calibration should only be carried out while pipelines and filters are clean, so that the Aspect has normal operating conditions. Calibration during abnormal conditions will give the Aspect a faulty baseline for monitoring, and will lead to unnecessary service messages.***

Calibration should only be carried out when:

- Commissioning a new installation of Aspect
- Filter TYPE is changed
- Environment has changed to other type of activity
- Changes of the pipe line design

## 9. MAINTENANCE

The AE2010 is, in addition to being highly sensitive for use in computer rooms, built to handle rough conditions with dust, condensation and corrosive gases. It is still important that regular maintenance is carried out to ensure optimal function.

### 9.1. SERVICE INTERVAL

Check the device six months after installation. If problems with air flow or other unwanted events have already occurred, consider changes in the programming, design of the pipe, or installation of condensation bottles / additional filters. Carry out service including replacement of DIAMANT and main filters (FI 003KP/FI 004KP), optionally clean the flow sensor. Consider if improved ventilation / filtering is needed in the room in question.

An annual inspection of the system shall be carried out. This inspection must be performed by authorized service personnel, and separate routines for such revision shall be followed. The table below lists recommended service intervals for some typical service tasks.

Action	Interval	Description
Verify / clean pipe	Once a year	Check joins and clamps. Clean clogged sampling holes if needed.
Replace main filter FI 003KP (004)	Once a year	Service code 4 is activated when main filter needs to be replaced.
Replace DIAMANT	Once a year	Service code 5 is activated when DIAMANT needs to be replaced.
Replace battery	Every third year or after service alert	Standard batteries have an expected lifetime of 3-5 years, after which the performance is reduced.
Replace sensor kit	Every eight years	According to European standards for sensors with contamination warning.
	Once a year in areas with stage/pyro effects	Stage smoke and pyrotechnics could leave particles of fatty residues in the sensor, affecting sensitivity.
	On service alert	Aspect warns with service code 7, 8, or 18 when needed (contamination or reduced fan performance).
	After a fire / significant smoke development	After a real fire, residual particles could remain in the sensor and affect sensitivity.

## 9.2. ANNUAL INSPECTION

The following items shall be reviewed during the annual inspection of the Aspect system:

### VERIFY BATTERY

The battery should be replaced every third year or after an automated battery warning.

### VERIFY PIPES

Check that the pipe lines are intact and not about to slip apart at the joins. Check that the pipes and sampling holes are open and free of dust or other objects.

### REPLACE DIAMANT

Replace the DIAMANT. Use the syringe (SS 001) to remove any dirt from the flow sensor before you assemble the new DIAMANT.

### REPLACE MAIN FILTERS

Wait for the fan to stop before removing the filter cartridge. The fan normally stops automatically when the door is opened.

Make sure the filter cartridge is fitted properly afterward. Use your thumb to feel that the cartridge front is flush with the two raised areas of the filter housing.

### VERIFY THE FILTER MONITOR

Hold the red button for 10 seconds-until the Aspect sounds one long beep. The fan stops for a maximum of 50 seconds. If the fan starts again and no service alert is triggered, the filter monitor is OK.

### PERFORM FUNCTIONAL TEST

Use suitable test smoke and apply the test smoke to the farthest sampling hole, see section [9.2.1. FUNCTIONAL TEST on page 81](#).

### VERIFY LED

Check that only the green LEDs on the CPU board are lit during normal operation.

## 9.2.1. FUNCTIONAL TEST

A functional test shall be performed during the annual inspection, and it is important to use the correct test materials. Test smoke intended for point detectors is so volatile; it will evaporate before it reaches the sensor. For this reason, it is recommended to use for example "Testifire" multi-stimulus detector tester or a smoke pen (TS 001).

### Test with TS 001

Test smoke shall be applied to the outermost sampling hole on the pipeline.

Allow wick to protrude 10 mm. That gives 2-3 minutes of smoke.

- a) Light wick and allow to burn for 10-15 sec. Try to keep distance to the pipe during this time
- b) Then blow out the flame. You will get a steady flow of smoke.
- c) Start test: Hold the smoke pen close to the sampling hole on the pipe for maximum 2-4 seconds. Then extinguish. (Recommended time for branched pipes: 4-8 seconds).
- d) To extinguish, replace cap.



TS 001

Copyright Björmax AB

*Use suitable test materials.*

## 9.2.2. FUNCTIONAL TEST STAND-ALONE

This function is only available for stand-alone. If the Aspect is connected to a fire alarm panel, any test mode is controlled from that panel.

By pressing and holding the red button for five seconds, the sounder output will temporarily configure to only activate in a short burst upon alarm, for more comfortable testing.



*The fire relay will still activate, so any dialers must be physically disconnected if they are not supposed to activate during testing.*

Test mode is indicated by flashing the sounder LED. Alarms can be reset without exiting the test mode. The test mode is ended automatically after 60 minutes, or by holding the green button for five seconds.

### 9.2.3. REPLACING THE MAIN FILTER

To change the filters, open the Aspect and wait for the fan to stop. Once the fan has stopped, pull the filter cartridge straight out.

Any dust that is scraped off in the filter openings when removing the cartridge must be wiped or vacuumed off. Remember to clean the grooves around the openings, build-up of dust may prevent a proper seal.

Filter elements are supplied as separate elements (FI 003KP or FI 004KP), or pre-installed in a complete cartridge (FS 2010). To replace separate elements, first remove old filters from the front piece by holding it as shown below. Bend the frame outwards, then pull towards your body.

Push the new filters into place in the cartridge.

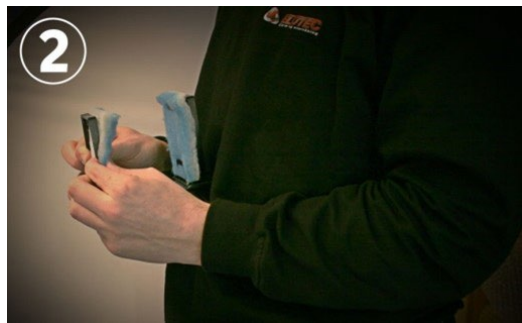

Finally, reinstall the cartridge, making sure that it is fitted tightly. Use your thumb to feel that the cartridge front is flush with the two raised areas of the filter housing.



## 9.2.4. INSPECTION AND REPLACEMENT OF DIAMANT

The DIAMANT particle filter is cast in clear plastic and is easy to inspect. The viewport in front appears when the main filter cartridge is removed.

Indications that the filter should be replaced:

- In case of service code is activated.
- Pervasive discoloration of the internal filter pad.
- Accumulation of foreign objects or water.

The filter should be replaced during the annual inspection.



Scan the QR code to see the replacing procedure on YouTube.  
[www.youtube.com/elotecn](http://www.youtube.com/elotecn)

## 9.2.5. REPLACING THE SENSOR KIT

The sensor kit includes a fan and sensor part.

Replacement is needed if the following occurs:

- In case of service signal (service code 7/8).
- Damaged or contaminated fan that affects the fan speed.
- Changes in the environment or such, that makes it suitable to replace the sensor kit with another type to change the properties of the Aspect. For example, make it less sensitive or more silent.

***The sensor kits cannot be exchanged between Nitro and Grizzle. Wrong type of sensor kit leads to fault signal for the sounder.***



Scan the QR code to see the replacing procedure on YouTube.  
[www.youtube.com/elotecn](http://www.youtube.com/elotecn)

***In the video, the procedure is performed with Aspect on a working bench.***

Be careful so that the sensor kit doesn't fall out, twitching the cables.

### ASPECT SENSORKIT-TOOL

The procedure can also be performed with the Aspect hanging on the wall, by using the ASPECT SensorKit-tool.

Assemble the ASPECT SensorKit-tool. Remove the two lowest screws and use the small spacers to press the bottom of the Aspect a little bit out from the wall.

Remove the filter and mount the ASPECT SensorKit-tool, as close to the door as possible.

Change the sensor kit in the same way as on the working bench. Let the sensor kit rest on the ledge of the tool while removing the sensor cables.

*Be careful so that the sensor kit doesn't fall out.*

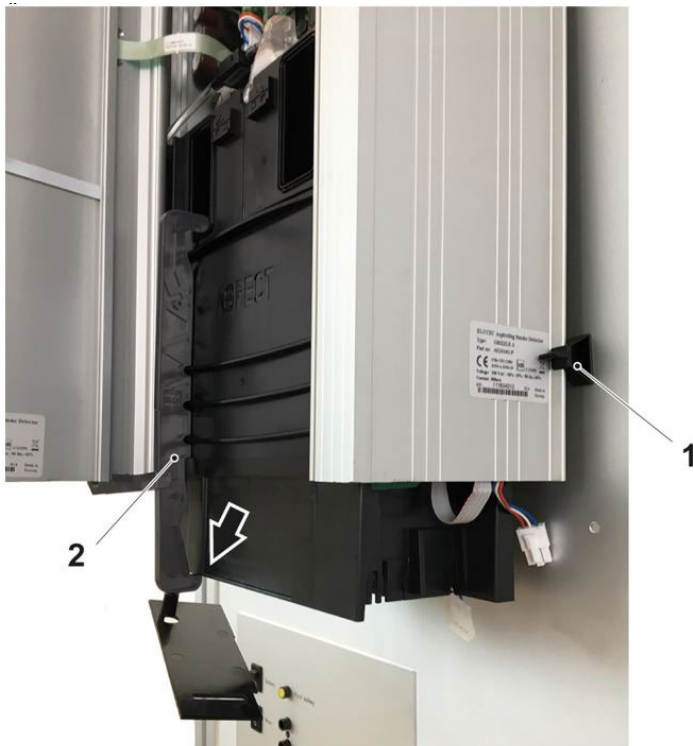

1. Spacers
2. ASPECT SensorKit-tool

The SensorKit-tool is included when ordering a sensor kit, and can also be ordered separately.

## 9.2.6. RESET THE EVENT LOG

It is possible to reset the event log by short circuit memory lock S100 for a moment. This can be applicable after the annual inspection is fulfilled. See number 13 in section [12.1. ASPECT CPU BOARD](#) on page 93.

*This procedure will only reset the event log in the Aspect. The complete event log in the Aspect tool will remain.*

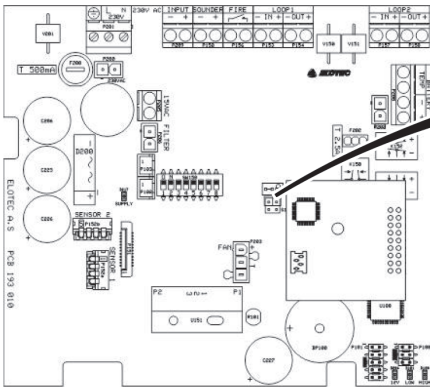

Reset

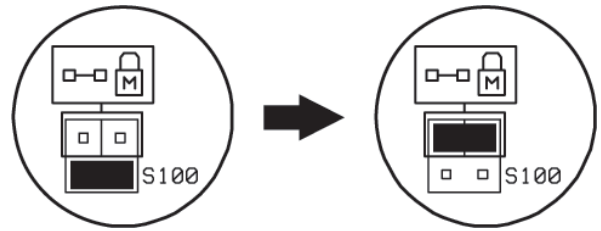

## 9.3. TRANSITION FROM NITRO TO GRIZZLE SENSOR

This is a guide on how to replace a Nitro sensor with a Grizzle sensor in the Elotec Aspect (AE2010). The reason for transitioning to the Grizzle sensor is that the Nitro sensor for Aspect 2010 (AE2010N) has been discontinued from our product range.

Ignore this if you are already using the Grizzle sensor.

### 9.3.1. REPLACING ASPECT-WIFI WITH ASPECT-BLE

When replacing the sensor from Nitro to Grizzle, the ASPECT-WIFI module must also be replaced with ASPECT-BLE to enable the change. This is required because the programming must be performed using Aspect Tool B, which is only supported when using the ASPECT-BLE module.

The ASPECT-BLE module makes it easy to access detailed operational information from the Aspect 2010 series through the Aspect Tool B app on smartphones and tablets. The combination of module and app also facilitates easy adjustments of operational parameters, commissioning, and service tasks.

ASPECT-BLE is compatible with all AE2010 units, although available functions may vary.

Before replacing the sensor and module, you must download Aspect Tool B. The app is available for both iOS and Android and requires either Bluetooth or Wifi to be enabled on your device. Remember to register if you are using the app for the first time.

Search for Aspect Tool B in the App Store and Google Play or scan one of the QR codes.



## 9.3.2. INSTALLATION OF ASPECT-BLE

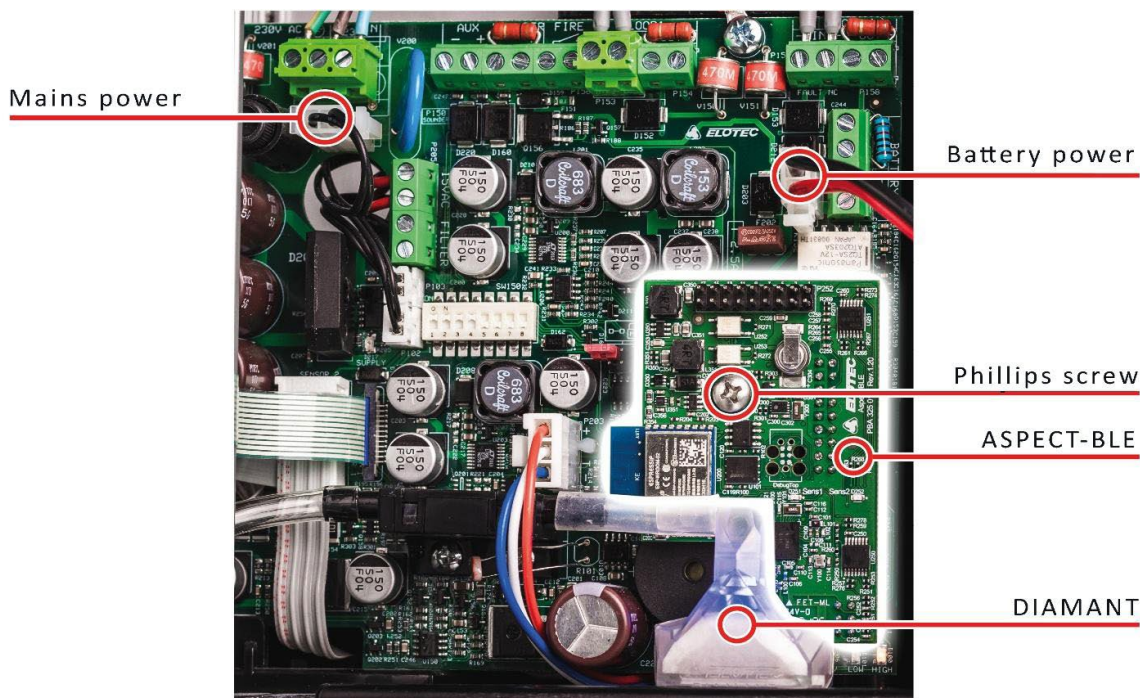

1. Disconnect mains power and battery from the Aspect 2010 before starting the installation.

*This will trigger a service message on the fire alarm control panel.*

2. Remove the filter drawer from the Aspect 2010 and set it aside.
3. Next, carefully detach the DIAMANT and set it aside to access the ASPECT-WIFI module.
4. Unscrew the Phillips screw holding the ASPECT-WIFI in place. If the Aspect is of the addressable type, also remove the interface card installed on top of the ASPECT-WIFI.
5. Pull the card straight out towards you to avoid bending the pins and remove the card.
6. Before installing the BLE card, move the jumper from the Wifi card, see picture, to the BLE card.

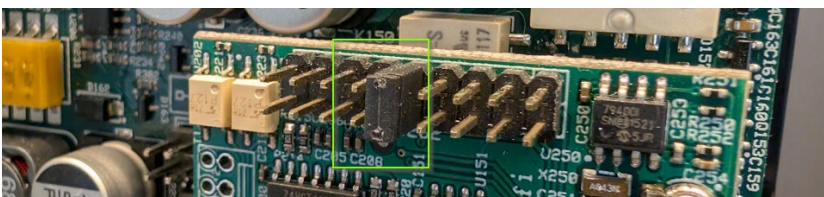

WIFI card with jumper

7. If you removed the interface card from ASPECT-WIFI, install it onto the new ASPECT-BLE card.
8. Place the spacer between the cards and reinstall the Phillips screw into the Aspect 2010.
9. Snap the Diamant back into position and reinstall the filter drawer.
10. Reconnect mains power and then the battery to the Aspect 2010 once you have verified that all components are properly installed and after replacing the SENSOR-KIT as described in section 9.2.5. [REPLACING THE SENSOR KIT](#) on page 83.
11. Close the door of the Aspect and connect to it using the Aspect Tool B app. The ASPECT-BLE is activated when the Diamant is illuminated blue by the module. If the Diamant does not illuminate, press the green button on the Aspect to activate the module.

### 9.3.2.1 COMPLETION AND TESTING



After completing these steps above, including replacing the sensor kit:

- Remove the tool, reinstall the filter drawer, reconnect mains power and battery to the Aspect, and close the door.
- Refer to section 9.3.3. [CONVERSION PROCESS IN ASPECT TOOL B](#) on page 88 for instructions on converting from Nitro to Grizzle using Aspect Tool B.

### 9.3.3. CONVERSION PROCESS IN ASPECT TOOL B

Connect to the Aspect using the Aspect Tool B app. To convert from Nitro to Grizzle, a dedicated button named “Convert Nitro to Grizzle” is available in the hamburger menu of the Aspect Tool B app.

This option is only available when connected to a Nitro-version Aspect. If not, the button will appear greyed out.

-  Installation Manual
-  Convert Nitro to Grizzle
-  Send Logs

Configuration steps:

- When the “Convert Nitro to Grizzle” button is pressed, the following pop-up will appear:

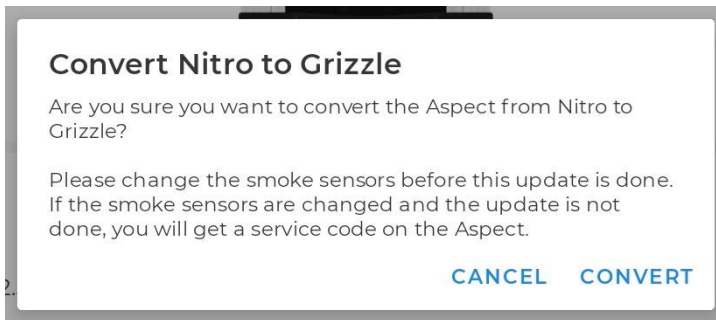

- The Aspect will perform a synchronization—please wait.
- After synchronization, you will see the following change in the app under Aspect. The sensor type will be updated from Nitro to Grizzle:

Nitro sensor before replacement:

Grizzle after replacement:

**Aspect Serial Number:**  
E13CFB53E0BC5FC0

**Device Name:**

**Sensor Type:** Nitro

**System Type:** Conventional

**Installed:** 29.04.2025

**1 Temperature:** 24°

**2 Temperature:** 24°

**Aspect Serial Number:**  
E13CFB53E0BC5FC0

**Device Name:**

**Sensor Type:** Grizzle

**System Type:** Conventional

**Installed:** 29.04.2025

**1 Temperature:** 24°

**2 Temperature:** 24°

## 10. COMMISSIONING THE ASPECT SYSTEM

This chapter describes the correct sequence to install, set and check your system. Make sure to read the complete technical description before commissioning the system.

### PREPARATIONS AND MOUNTING

- a) Add the Aspect into the configuration in EBLWin. See section [8.4. CONFIGURATION on page 71](#).
- b) Download the configuration into the EBL CIE. See the Planning instructions for the system.
- c) Set the Aspect address and mode. See section [8.5. SET THE COM LOOP ADDRESS on page 75](#)
- d) Mount the pipes and THUB according to the sampling pipe layout. See section [8.1.2. PIPES on page 54](#).
- e) Mount the Aspect on the wall, see section [8.3. ASPECT on page 66](#).

### CONNECTIONS

- f) Connect the Aspect to the COM loop, see section [8.6. WIRING on page 76](#).
- g) Connect to 230 V.
- h) Connect the battery.
- i) Calibrate the Aspect, see section [8.7. CALIBRATION on page 78](#).

### CHECK

- j) Measure the vacuum in the last hole in the pipe with the ELOVAC manometer. See section [6.1. ELOVAC on page 37](#).
- k) Check that the mains lamp (green LED on the Aspect (front) is ON.
- l) Check that the battery is connected.
- m) Check the status of the LEDs on the CPU board. Only the green LED should be ON when the fan runs.
- n) Set the CIE to "Test mode" and check the communication between the CIE and the Aspect.

### VERIFY

- o) Make a smoke test in the last hole on the pipes and verify that the transportation time is within 120 seconds, or according to local regulations. Please remember to make a new smoke test after any changes to the configuration.

# 11. TECHNICAL DATA

## 11.1. GRIZZLE AND STAND-ALONE

Supply voltage	230 VAC, 50 Hz
Current consumption:	Average 500 mA . / Peak 1,7A max
COM loop voltage (Valid for Grizzle only): Allowed Normal  COM Loop Current: Quiescent Active	12-30V DC 24V DC  2,1 mA 2,1 mA
Sensitivity: Grizzle (Class B) Grizzle (Class C)	0,15 dB /meter (Smoke density) 100 m pipe/10 holes 2 dB /meter (Smoke density) 2X100 m pipe/20 holes
Noise level	Nom. 55 dB @ 1 m 45-50 dB @ 1 m w/ AU 002
Material: Cover and Base:	Extruded aluminum profile with PC/ABS top and bottom
Operating temperature	-30 to +55 °C
Storage temperature	-30 to +55 °C
Ambient humidity	Maximum 98 %
Pressure	Max. 75 Pa under pressure in rooms with sampling points
Ingress Protection	IP 44
Weight	6.6 kg
Size: W x H x D	272 x 530 x 143 mm

## 11.2.ELOCLEAN



For EloClean delivered before September 2022.

Supply voltage	230 VAC, 50 Hz
Outputs	1 pcs, fault relay, NC clean contact Max.2 A @ 30 V DC
Battery	9V LI-SOCL2, lithium battery; to keep track of the cleaning intervals
Material: Cover and Base:	Extruded aluminum profile with PC/ABS top and bottom
Operating temperature:	-30 to +60 °C
Storage temperature	-30 to +60 °C
Ambient humidity	Maximum 98 %
Pressure	3200Pa (with sampling points on the pipe this value is rapidly decreasing)
Ingress Protection	IP 44
Weight	10.2 kg
Size: W x H x D	272 x 578 x 143 mm



For EloClean delivered after September 2022.

Supply voltage	230 VAC, 50 Hz
Current consumption	Operation: 2 A Standby: 31 mA
Outputs	1 pcs, fault relay, NC clean contact Max.2 A @ 30 V DC
Battery	9V LI-SOCL2, lithium battery; to keep track of the cleaning intervals
Material: Cover and Base:	Extruded aluminum profile with PC/ABS top and bottom
Operating temperature	-30 to +60 °C
Storage temperature	-30 to +60 °C
Ambient humidity	Maximum 98 %
Pressure	5600Pa (with sampling points on the pipe this value is rapidly decreasing)
Ingress Protection	IP 44
Weight	10.2 kg
Size: W x H x D	272 x 578 x 178 mm

## 12. APPENDIX

## 12.1. ASPECT CPU BOARD

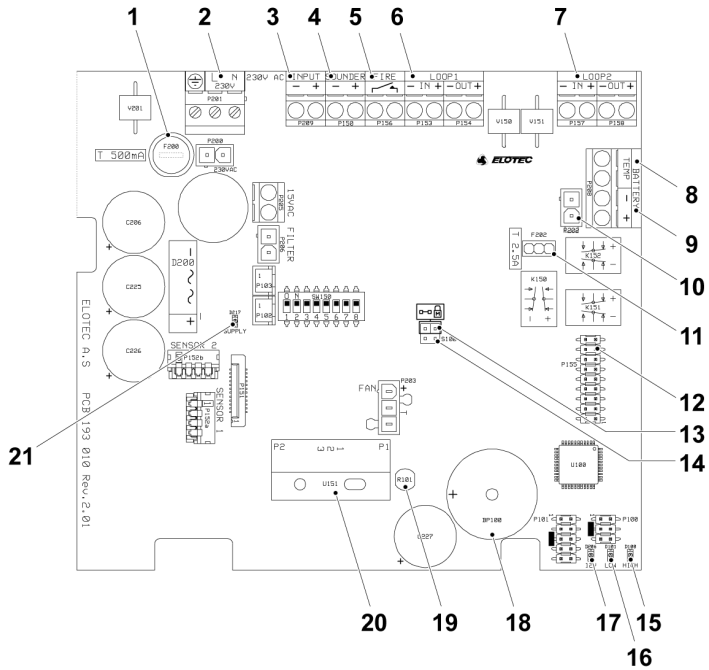

- |  |   |
|--|---|
| <ol style="list-style-type: none"> <li>1. Main fuse, 500mA</li> <li>2. Mains connection</li> <li>3. Aux input, configurable as disablement or fault input (Must not be used *)</li> <li>4. Sounder output (Not used *)</li> <li>5. Relay output, NO (Must not be used *)</li> <li>6. Loop connections area 1, IN</li> <li>7. Loop connections area 1, OUT (Not used *)</li> <li>8. Battery temperature monitor connection<br/>Connect NTC, art no NTC 000 001 for monitoring<br/>Connect 10KΩ resistor if monitoring is not used</li> <li>9. External PSU connection 12-24V</li> <li>10. Internal battery connection</li> <li>11. Battery fuse, 2.5 A</li> <li>12. Expansion port for addressing interfaces</li> </ol> | <ol style="list-style-type: none"> <li>13. Memory lock for programming</li> <li>14. S100, clear event log</li> <li>15. Yellow LED, indicator for high air flow through flow sensor</li> <li>16. Red LED, indicator for low air flow through flow sensor</li> <li>17. Green LED, power indicator</li> <li>18. Internal buzzer</li> <li>19. Photo sensor</li> <li>20. Flow sensor</li> <li>21. Green LED, C-filter</li> </ol> |
|--|---|

\* Not used for addressable versions, when Aspect interface board 4586 is mounted.

## 12.2. ADDITIONAL CIRCUIT BOARDS

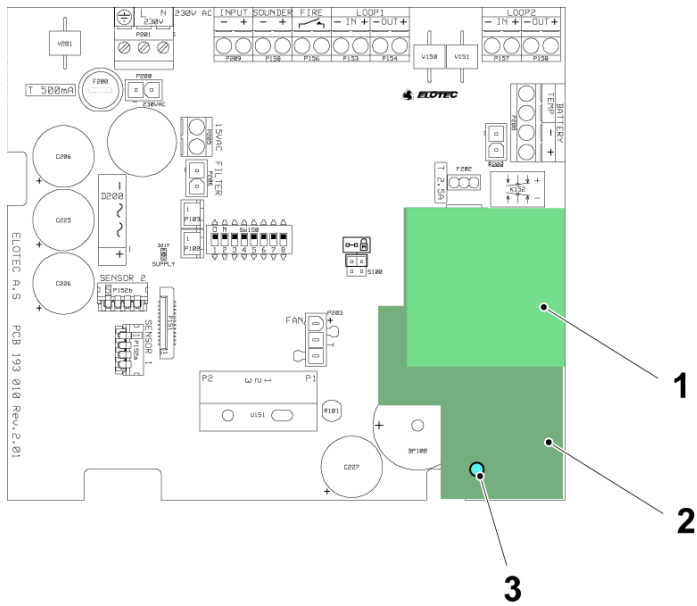

1. Aspect interface board 4586 – interface for EBL
  2. Aspect Wi-Fi – for connection to Aspect tool
- Blue LED – The LED is lit when Wi-Fi is activated

## 12.3. PROGRAM PARAMETERS

Program	Setting	Function
<b>P1</b>		<b>Flow deviation threshold</b>
	1	Automatic (default)
	2-10	2 = most sensitive    10 = least sensitive (4 = EN54, 9 = agriculture)
<b>P2</b>		<b>Power supply</b>
	1	Internal, with temperature monitoring of battery
	2	External power 12V
	3	Internal, no temperature monitoring of battery (default)
	4	External power 24V
<b>P3</b>		<b>Aux input function</b>
	1	Fault input When using internal supply (P2=1): generic fault input. When using external supply (P2=2): external supply fault
	2	Disable button, pulse (default)
	3	Disabled when closed
<b>P4</b>		<b>C- filter during mains fault</b>
	1	Condensation filter on as needed (default)
	2	Condensation filter on, but turned off during mains fault if internal supply is configured (P2=1)
	3	Condensation filter on as needed, but reduced to half effect during mains fault if internal supply is configured (P2=1 or 3)
<b>P5</b>		<b>Indication of mains outage</b>
	1	Mains fault is indicated immediately (< 5 seconds)
	2	Mains fault is indicated after 20 minutes – VdS/EN54
	3	Mains fault is indicated after 2 hours (default)
<b>P6</b>		<b>Indication of flow deviation</b>
	1	4,5 minutes for both high and low air flow – (VdS/EN54)
	2	6 hours for high air flow, 30 minutes for low air flow (for agriculture) (default)
	3	6 hours for both high and low air flow
	4	12 hours for both high and low air flow
	5	24 hours for both high and low air flow
	6	48 hours for both high and low air flow

Program	Setting	Function
<b>P7</b>		<b>Fan speed</b>
	1-10	1 = lowest 10 = highest speed. (standard = 10)
<b>P8</b>		<b>Signaling on loop when disabled</b>
	1	Generate 2 and 4 Hz on loop, fan stops
	2	Local disablement, fan stops (not VdS/EN54)
	3	Generate 2 and 4 Hz on loop, fan keeps running (default)
	4	Local disablement, fan keeps running (not VdS/EN54)
<b>P9</b>		<b>Hyper Sense</b>
	1	Off (default)
	2	On – increased sensitivity. C-filter is turned off. Recommended for dry premises. (not VdS/EN54)
<b>P10*</b>		<b>Automatic calibration</b>
	1	48 hours (default)
	2	7 days
	3	Greenhouses
<b>P11</b>		<b>Disablement duration (Stand alone only)</b>
	1	30 minutes
	2	1 hour
	3	2 hours
	4	4 hours (default)
	5	8 hours
	6	No disablements
<b>For addressable Aspect</b>		Keep default setting (4) Set disablement duration via EBLWin.
<b>P13</b>		<b>Battery option</b>
	1	Lead battery (Standard)
	2	LifePO4

\* P10 is only active when P1=1, all other settings of P1 makes P10 inactive.

## 12.3.1. PROGRAM PARAMETERS WITHOUT ASPECT TOOL

### GRIZZLE

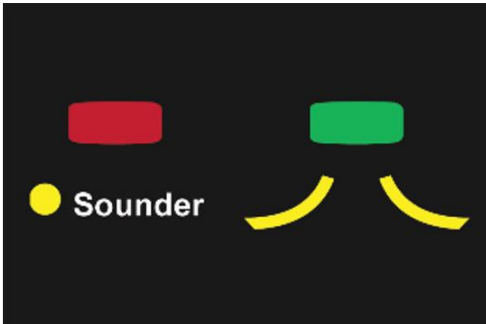





- a) Remove memory lock; hold both buttons until Aspect sounds two short beeps. The power LED blinks slowly.
- b) Hold green button and press red button the number of times to select P1-P11.
- c) Hold red button and press green button the desired number of times to set value.
- d) When pressing the green button to read the current value, P1-11 is indicated first, using blinks of the sounder LED, then the value, using yellow LEDs for both areas.

*Replace memory lock when programming is completed.*

## 12.4. SERVICE CODES

The table below describes the various service codes and suggested actions.

Code	Description	Action
1	Mains supply missing	First, verify external supply / fuse. Then check the mains connection and fuse F200 in the Aspect.
2	Not calibrated	<p>Perform calibration for air flow monitoring, see section <a href="#">8.7. CALIBRATION</a> on page 78.</p> <p>An alarm resistor is required for the stand-alone Aspect to fulfil EN54-13.                      A: Alarm                      B: Reset                      C: Fault</p> <p><b>Regarding C; the wire is supervised for open circuit only.</b></p> <p>See EBLWin configuration in <a href="#">8.4. CONFIGURATION</a> on page 71.</p> 
3	Check air flow	<p>This is a monthly air flow test to check our internal filter monitoring sensor.                      Check the following:</p> <ul style="list-style-type: none"> <li>Open the door to make the fan stop, remove the main filters then the red "LOW" LED will be ON inside on the PCB. (The red LED indicates no flow in the pipeline). If the red LED is off, you have an internal PCB fault.</li> <li>If the red LED is ON, then inspect the pipeline and check external pressure differences in the rooms that might cause reversed airflow in the moment we automatically stop the fan during the monthly test.                      Pressure and very high temperature differences could create a chimney effect</li> </ul>
4	Check filters / pipes	<p>The Aspect has detected that the air flow through the filter is abnormal.                      Check the following:</p> <ul style="list-style-type: none"> <li>Verify that main filters are properly installed, and replace dirty filters if required, see section <a href="#">9.2.3. REPLACING THE MAIN FILTER</a> on page 82.</li> <li>Verify that all pipes are properly connected at the joins and undamaged.</li> <li>Check that the NOW value moves into the green area / yellow LED goes out.</li> </ul> 
5	Check pipe / air flow	<p>The Aspect has detected that the air flow through the filter is abnormal.                      Check the following:</p> <ul style="list-style-type: none"> <li>Verify that the fan is running</li> <li>Verify that the pipeline isn't clogged – measure vacuum in the farthest hole has over 1,0 cmH2O with EIoVac. Optionally, break the pipeline near the Aspect, for example by unscrewing the condensation reservoir; if this makes the red "LOW" LED go out, pipelines must be cleaned.</li> <li>Replace the DIAMANT filter / alternately clean the air flow sensor.</li> </ul> <p>Use Aspect Tool and the flow meter to observe that the airflow values are within the thresholds are OK. Check that the red "LOW" LED is not lit.</p> 
6	Open circuit on the sounder output	Verify cable and EOL resistor (1KΩ) on sounder output / parallel indicator output
7	Contaminated sensor, area 1	<b>Replace sensor kit</b>
8	Contaminated sensor, area 2	<b>Replace sensor kit.</b>

Code	Description	Action
9	Replace battery	High internal resistance.
10	Replace battery / check sensor	Battery temperature is too high. Check the following: <ul style="list-style-type: none"> <li>• Verify that the temperature sensor is not short circuited.</li> <li>• Verify that temperature is below the accepted limit, also check the ambient temperature.</li> <li>• Check the placement of the Aspect or the environment.</li> <li>• Battery should be replaced after exposure to excessive temperatures</li> </ul>
11	Check connection of battery temp sensor	The Aspect has detected missing temperature sensor or resistor. Check the following: <ul style="list-style-type: none"> <li>• Check the connection for the battery temperature sensor.</li> <li>• NTC or resistor (10KΩ) must be fitted.</li> </ul>
12	Alarm / fault from Aux input	The Aspect has detected an alarm/fault from auxiliary connected equipment. <ul style="list-style-type: none"> <li>• Inspect external equipment connected to the Aux input.</li> </ul>
13	Low supply voltage	The Aspect has detected low supply voltage. <ul style="list-style-type: none"> <li>• Check mains voltage / external power supply unit.</li> </ul>
14	Check battery connection / fuse	The Aspect has detected low battery voltage. Check the following: <ul style="list-style-type: none"> <li>• This is normal after extended power outages – check battery voltage.</li> <li>• Check the battery voltage in Aspect Tool app</li> <li>• Verify battery connection and that the fuse F202 is OK.</li> <li>• Replace battery if connections are OK and condition cannot be reset after 24 h.</li> </ul> 
15	Overtoltage damage to the charging circuit	The Aspect has detected high battery voltage. Check the following: <ul style="list-style-type: none"> <li>• Normally caused by surge damage on charging circuit – defect PCB.</li> <li>• Verify battery connection and fuse F202, see <a href="#">12.1. ASPECT CPU BOARD on page 93</a>.</li> </ul>
16	Low charging voltage	The Aspect has detected low charging current. Check the following: <ul style="list-style-type: none"> <li>• Verify battery connection and fuse F202, see <a href="#">12.1. ASPECT CPU BOARD on page 93</a></li> </ul>
17	Battery fully discharged	The Aspect has detected high charging current. Do the following: <ul style="list-style-type: none"> <li>• Replace battery – deep discharge.</li> </ul>
18	Wrong speed on the fan	The Aspect has detected a defect fan. Do the following: <ul style="list-style-type: none"> <li>• Replace sensor kit, including fan.</li> </ul> Contamination or damage prevents the fan from maintaining the correct speed.
19	DEMO mode activated	Not in use for Aspects produced after year 2020. Demo mode is activated by pressing green button "too long". To leave Demo mode, break the power to Aspect completely.
23	Invalid values during calibration	The Aspect has too low air flow to calibrate the Aspect. Do the following: <ul style="list-style-type: none"> <li>• Increase flow in pipeline to make calibration possible.</li> <li>• Replace DIAMANT, clean flow sensor or remove dust from the pipes.</li> </ul>
26	Charger damaged	Charger damaged by battery being connected with reverse polarity. <ul style="list-style-type: none"> <li>• Replace main PCB</li> </ul>
27	Temperature below 0 °C	<ul style="list-style-type: none"> <li>• Charging of LifePO4 battery has been paused until temperature rises.</li> </ul>

## 12.4.1. READ OUT SERVICE CODES WITHOUT THE ASPECT TOOL

Up to 10 service codes are saved in the Aspect, and can be read.

Reset the event log in the Aspect to see only the currently active faults. See [9.2.6. RESET THE EVENT LOG on page 85](#).

### GRIZZLE



a) Hold green button 5 sec

b) Short beep



c) Press green button once

d) Long beeps



e) X number of blinks = service code number in table



f) To read out next service code, repeat step c) to e)



g) End readout by pressing the red button.

## 13. APPROVALS

### GRIZZLE AE2010G-P

Applicable directive/ Approval	Applicable standards	Notified body
CPR	Grizzle	VdS No. 0786-CPR-21084
	EN 54-4 EN 54-20 Classes B and C	
VdS	EN 54-4 EN 54-20 VdS 2344 VdS 2203 VdS 2504 VdS 2541	VdS No. G218067
EMC	EN 61000-4 (Emission) EN 50130-4 (Immunity)	Declaration made by manufacturer (Elotec AS)
LVD	IEC 62368-1 (Low voltage)	
RoHS	EN IEC 63000	

### GRIZZLE AE2010G-S

Applicable directive/ Approval	Applicable standards	Notified body
CPR	EN 54-4 EN 54-20 Classes B and C	VdS No. 0786-CPR-21084
VdS	EN 54-4 EN 54-20 VdS 2344 VdS 2203 VdS 2504 VdS 2541	VdS No. G218069
EMC	EN 61000-4 (Emission) EN 50130-4 (Immunity)	Declaration made by manufacturer (Elotec AS)
LVD	IEC 62368-1 (Low voltage)	
RoHS	EN IEC 63000	



---

DOCUMENT NAME: TECHNICAL DESCRIPTION AE2010G-P, AE2010G-S  
DOCUMENT NUMBER: MEW01855 EN  
DATE OF ISSUE: 2016-10-31  
REV: 16  
DATE OF REVISION: 2026-05-22

**Panasonic Fire & Security Europe AB**

Jungmansgatan 12  
SE-211 11 Malmö  
Sweden  
Tel: +46 (0)40 697 70 00